

TRACTATENBLAD

VAN HET

KONINKRIJK DER NEDERLANDEN

JAARGANG 2006 Nr. 20

A. TITEL

*Protocol van 1988 bij het Internationaal Verdrag betreffende de
uitwatering van schepen, 1966;
(met Bijlagen)
Londen, 11 november 1988*

B. TEKST

De Engelse en de Franse tekst van het Protocol zijn geplaatst in
Trb. 1989, 134.

Resolutie MSC. 143 (77)

Op 5 juni 2003 heeft de Maritieme Veiligheidscommissie in overeenstemming met artikel VI van het Protocol een resolutie aangenomen houdende wijzigingen in Bijlage B bij het Protocol.

De Engelse tekst¹⁾ van de resolutie luidt als volgt:

Resolution MSC.143(77)

(adopted on 5 June 2003)

**Amendments to the Protocol of 1988 relating to the International
Convention on Load Lines, 1966**

The Maritime Safety Committee,

Recalling Article 28(b) of the Convention on the International Maritime Organization concerning the functions of the Committee,

¹⁾ De Arabische, de Franse, de Russische en de Spaanse tekst zijn niet afgedrukt.

Recalling further article VI of the Protocol of 1988 relating to the International Convention on Load Lines, 1966 (hereinafter referred to as “the 1988 Load Lines Protocol”) concerning amendment procedures,

Having considered, at its seventy-seventh session, amendments to the 1988 Load Lines Protocol proposed and circulated in accordance with paragraph 2(a) of article VI thereof,

1. Adopts, in accordance with paragraph 2(d) of article VI of the 1988 Load Lines Protocol, amendments to Annex B to the 1988 Load Lines Protocol, the text of which is set out in the Annex to the present resolution;

2. Determines, in accordance with paragraph 2(f)(ii)(bb) of article VI of the 1988 Load Lines Protocol, that the said amendments shall be deemed to have been accepted on 1 July 2004, unless, prior to that date, more than one third of the Parties to the 1988 Load Lines Protocol or Parties the combined merchant fleets of which constitute not less than 50% of the gross tonnage of all the merchant fleets of all Parties, have notified their objections to the amendments;

3. Invites the Parties concerned to note that, in accordance with paragraph 2(g)(ii) of article VI of the 1988 Load Lines Protocol, the amendments shall enter into force on 1 January 2005, upon their acceptance in accordance with paragraph 2 above;

4. Requests the Secretary-General, in conformity with paragraph 2(e) of article VI of the 1988 Load Lines Protocol, to transmit certified copies of the present resolution and the text of the amendments contained in the Annex to all Parties to the 1988 Load Lines Protocol;

5. Further requests the Secretary-General to transmit copies of this resolution and its Annex to Members of the Organization which are not Parties to the 1988 Load Lines Protocol.

Annex

Amendments to Annex B to the Protocol of 1988 relating to the International Convention on Load Lines, 1966

1. The existing text of Annex I to Annex B is replaced by the following:

“ANNEX I

REGULATIONS FOR DETERMINING LOAD LINES

CHAPTER I

GENERAL

The regulations assume that the nature and stowage of the cargo, ballast, etc., are such as to secure sufficient stability of the ship and the avoidance of excessive structural stress.

The regulations also assume that where there are international requirements relating to stability or subdivision, these requirements have been complied with.

Regulation 1

Strength and intact stability of ships

- (1) The Administration shall satisfy itself that the general structural strength of the ship is adequate for the draught corresponding to the freeboard assigned.
- (2) A ship which is designed, constructed and maintained in compliance with the appropriate requirements of an organization, including a classification society, which is recognized by the Administration or with applicable national standards of the Administration in accordance with the provisions of regulation 2-1, may be considered to provide an acceptable level of strength. The above provisions shall apply to all structures, equipment and fittings covered by this annex for which standards for strength and construction are not expressly provided.
- (3) Ships shall comply with an intact stability standard acceptable to the Administration.

Regulation 2

Application

- (1) Ships with mechanical means of propulsion or lighters, barges or other ships without independent means of propulsion, shall be assigned freeboards in accordance with the provisions of regulations 1 to 40, inclusive.
- (2) Ships carrying timber deck cargoes may be assigned, in addition to the freeboards prescribed in paragraph (1), timber freeboards in accordance with the provisions of regulations 41 to 45.

- (3) Ships designed to carry sail, whether as the sole means of propulsion or as a supplementary means, and tugs, shall be assigned freeboards in accordance with the provisions of regulations 1 to 40, inclusive. Additional freeboard may be required as determined by the Administration.
- (4) Ships of wood or of composite construction, or of other materials the use of which the Administration has approved, or ships whose constructional features are such as to render the application of the provisions of this Annex unreasonable or impracticable, shall be assigned freeboards as determined by the Administration.
- (5) Regulations 10 to 26, inclusive, shall apply to every ship to which a minimum freeboard is assigned. Relaxations from these requirements may be granted to a ship to which a greater than minimum freeboard is assigned, on condition that the Administration is satisfied with the safety conditions provided.
- (6) Where the assigned summer freeboard is increased such that the resulting draught is not more than that corresponding to a minimum summer freeboard for the same ship, but with an assumed freeboard deck located a distance below the actual freeboard deck at least equal to the standard superstructure height, the conditions of assignment in accordance with regulations 12, 14-1 through 20, 23, 24 and 25, as applicable, to the actual freeboard deck may be as required for a superstructure deck.
- (7) Unless expressly provided otherwise, the regulations of this Annex shall apply to ships the keels of which are laid or which are at a similar stage of construction on or after 1 January 2005.
- (8) For ships the keels of which are laid or which are at a similar stage of construction before 1 January 2005, the Administration shall ensure that the requirements which are applicable under the International Convention on Load Lines, 1966, as modified by the Protocol of 1988 relating thereto, adopted by the International Conference on Harmonized System of Survey and Certification, 1988, are complied with.
- (9) High-speed craft which comply with the requirements of the International Code of Safety for High-Speed Craft, 2000 (2000 HSC Code), adopted by the Maritime Safety Committee of the Organization by resolution MSC.97(73) and which have been surveyed and certified as provided in the Code shall be deemed to have complied with the requirements of this Annex. The certificates and permits issued under the 2000 HSC Code shall have the same force and the same recognition as the certificates issued under this Annex.

Regulation 2-1

Authorization of recognized organizations

Organizations, including classification societies, referred to in article 13 of the Convention and regulation 1(2) shall comply with the guidelines adopted by the Organization by resolution A.739(18), as may be amended by the Organization, and the specifications adopted by the Organization by resolution A.789(19), as may be amended by the Organization, provided that such amendments are adopted, brought into force and take effect in accordance with the provisions of article VI of the present Protocol.

Regulation 3

Definitions of terms used in the Annexes

(1) Length

- (a) The length (L) shall be taken as 96% of the total length on a waterline at 85% of the least moulded depth measured from the top of the keel, or as the length from the fore side of the stem to the axis of the rudder stock on that waterline, if that be greater.
- (b) For ships without a rudder stock, the length (L) is to be taken as 96% of the waterline at 85% of the least moulded depth.
- (c) Where the stem contour is concave above the waterline at 85% of the least moulded depth, both the forward terminal of the total length and the fore-side of the stem respectively shall be taken at the vertical projection to that waterline of the aftermost point of the stem contour (above that waterline) (see figure 3.1).
- (d) In ships designed with a rake of keel the waterline on which this length is measured shall be parallel to the designed waterline at 85% of the least moulded depth D_{\min} , found by drawing a line parallel to the keel line of the vessel (including skeg) tangent to the moulded sheer line of the freeboard deck. The least moulded depth is the vertical distance measured from the top of the keel to the top of the freeboard deck beam at side at the point of tangency (see figure 3.2).

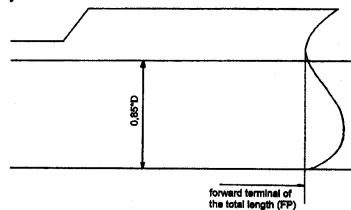

Figure 3.1

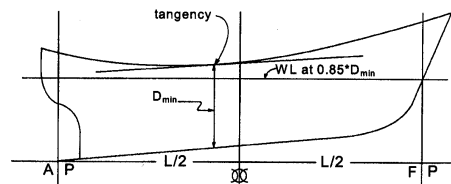

Figure 3.2

- (2) *Perpendiculars.* The forward and after perpendiculars shall be taken at the forward and after ends of the length (L). The forward perpendicular shall coincide with the foreside of the stem on the waterline on which the length is measured.
- (3) *Amidships.* Amidships is at the middle of the length (L).
- (4) *Breadth.* Unless expressly provided otherwise, the breadth (B) is the maximum breadth of the ship, measured amidships to the moulded line of the frame in a ship with a metal shell and to the outer surface of the hull in a ship with a shell of any other material.
- (5) *Moulded depth*
 - (a) The moulded depth is the vertical distance measured from the top of the keel to the top of the freeboard deck beam at side. In wood and composite ships the distance is measured from the lower edge of the keel rabbet.
Where the form at the lower part of the midship section is of a hollow character, or where thick garboards are fitted, the distance is measured from the point where the line of the flat of the bottom continued inwards cuts the side of the keel.
 - (b) In ships having rounded gunwales, the moulded depth shall be measured to the point of intersection of the moulded lines of deck and sides, the lines extending as though the gunwale were of angular design.
 - (c) Where the freeboard deck is stepped and the raised part of

the deck extends over the point at which the moulded depth is to be determined, the moulded depth shall be measured to a line of reference extending from the lower part of the deck along a line parallel with the raised part.

(6) *Depth for freeboard (D)*

- (a) The depth for freeboard (D) is the moulded depth amidships, plus the freeboard deck thickness at side.
- (b) The depth for freeboard (D) in a ship having a rounded gunwale with a radius greater than 4% of the breadth (B) or having topsides of unusual form is the depth for freeboard of a ship having a midship section with vertical topsides and with the same round of beam and area of topside section equal to that provided by the actual midship section.

(7) *Block coefficient*

- (a) The block coefficient (C_b) is given by:

$$C_b = \frac{\nabla}{L \cdot B \cdot d_1}; \text{ where}$$

∇ is the volume of the moulded displacement of the ship, excluding appendages, in a ship with a metal shell, and is the volume of displacement to the outer surface of the hull in a ship with a shell of any other material, both taken at a moulded draught of d_1 ; and where d_1 is 85% of the least moulded depth.

- (b) When calculating the block coefficient of a multi-hull craft, the full breadth (B) as defined in paragraph (4) is to be used and not the breadth of a single hull.
- (8) *Freeboard.* The freeboard assigned is the distance measured vertically downwards amidships from the upper edge of the deck line to the upper edge of the related load line.
- (9) *Freeboard deck.*

- (a) The freeboard deck is normally the uppermost complete deck exposed to weather and sea, which has permanent means of closing all openings in the weather part thereof, and below which all openings in the sides of the ship are fitted with permanent means of watertight closing.
- (b) Lower deck as a freeboard deck
At the option of the owner and subject to the approval of the Administration, a lower deck may be designated as the freeboard deck provided it is a complete and permanent deck continuous in a fore and aft direction at least between the machinery space and peak bulkheads and continuous athwartships.
 - (i) When this lower deck is stepped the lowest line of the deck and the continuation of that line parallel to the upper part of the deck is taken as the freeboard deck.
 - (ii) When a lower deck is designated as the freeboard

deck, that part of the hull which extends above the freeboard deck is treated as a superstructure so far as concerns the application of the conditions of assignment and the calculation of freeboard. It is from this deck that the freeboard is calculated.

- (iii) When a lower deck is designated as the freeboard deck, such deck as a minimum shall consist of suitably framed stringers at the ship sides and transversely at each watertight bulkhead which extends to the upper deck, within cargo spaces. The width of these stringers shall not be less than can be conveniently fitted having regard to the structure and the operation of the ship. Any arrangement of stringers shall be such that structural requirement can also be met.
- (c) Discontinuous freeboard deck, stepped freeboard deck.
 - (i) Where a recess in the freeboard deck extends to the sides of the ship and is in excess of one metre in length, the lowest line of the exposed deck and the continuation of that line parallel to the upper part of the deck is taken as the freeboard deck (see figure 3.3).
 - (ii) Where a recess in the freeboard deck does not extend to the sides of the ship, the upper part of the deck is taken as the freeboard deck.
 - (iii) Recesses not extending from side to side in a deck below the exposed deck, designated as the freeboard deck, may be disregarded, provided all openings in the weather deck are fitted with weathertight closing appliances.
 - (iv) Due regard shall be given to the drainage of exposed recesses and to free surface effects on stability.
 - (v) Provisions of subparagraphs (i) through (iv) are not intended to apply to dredgers, hopper barges or other similar types of ships with large open holds, where each case requires individual consideration.

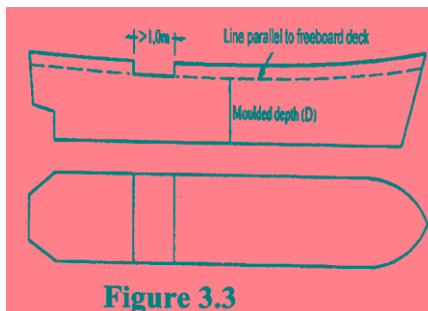

Figure 3.3

(10) *Superstructure*

- (a) A superstructure is a decked structure on the freeboard deck, extending from side to side of the ship or with the side plating not being inboard of the shell plating more than 4% of the breadth (B).
- (b) An enclosed superstructure is a superstructure with:
 - (i) enclosing bulkheads of efficient construction;
 - (ii) access openings, if any, in these bulkheads fitted with doors complying with the requirements of regulation 12;
 - (iii) all other openings in sides or ends of the superstructure fitted with efficient weathertight means of closing.

A bridge or poop shall not be regarded as enclosed unless access is provided for the crew starting from any point on the uppermost complete exposed deck or higher to reach machinery and other working spaces inside these superstructures by alternative means which are available at all times when bulkhead openings are closed.

- (c) The height of a superstructure is the least vertical height measured at side from the top of the superstructure deck beams to the top of the freeboard deck beams.
- (d) The length of a superstructure (S) is the mean length of the part of the superstructure which lies within the length (L).
- (e) Bridge. A bridge is a superstructure which does not extend to either the forward or after perpendicular.
- (f) Poop. A poop is a superstructure which extends from the after perpendicular forward to a point which is aft of the forward perpendicular.
The poop may originate from a point aft of the aft perpendicular.
- (g) Forecastle. A forecastle is a superstructure which extends from the forward perpendicular aft to a point which is forward of the after perpendicular. The forecastle may originate from a point forward of the forward perpendicular.
- (h) Full superstructure. A full superstructure is a superstructure which, as a minimum, extends from the forward to the after perpendicular.
- (i) Raised quarterdeck. A raised quarterdeck is a superstructure which extends forward from the after perpendicular, generally has a height less than a normal superstructure, and has an intact front bulkhead (sidescuttles of the non-opening type fitted with efficient deadlights and bolted man hole covers) (see figure 3.4). Where the forward bulkhead is not intact due to doors and access openings, the superstructure is then to be considered as a poop.

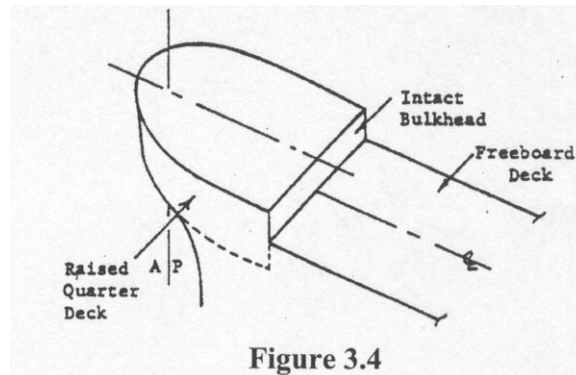

- (11) *Superstructure deck.* A superstructure deck is a deck forming the upper boundary of a superstructure.
- (12) *Flush deck ship.* A flush deck ship is a ship which has no superstructure on the freeboard deck.
- (13) *Weathertight.* Weathertight means that in any sea conditions water will not penetrate into the ship.
- (14) *Watertight.* Watertight means capable of preventing the passage of water through the structure in either direction with a proper margin of resistance under the pressure due to the maximum head of water which it might have to sustain.
- (15) *Well.* A well is any area on the deck exposed to the weather, where water may be entrapped. Wells are considered to be deck areas bounded on two or more sides by deck structures.

Regulation 4

Deck line

The deck line is a horizontal line 300 mm in length and 25 mm in breadth. It shall be marked amidships on each side of the ship, and its upper edge shall normally pass through the point where the continuation outwards of the upper surface of the freeboard deck intersects the outer surface of the shell (as illustrated in figure 4.1), provided that the deck line may be placed with reference to another fixed point on the ship on condition that the freeboard is correspondingly corrected. The location of the reference point and the identification of the freeboard deck shall

in all cases be indicated on the International Load Line Certificate.

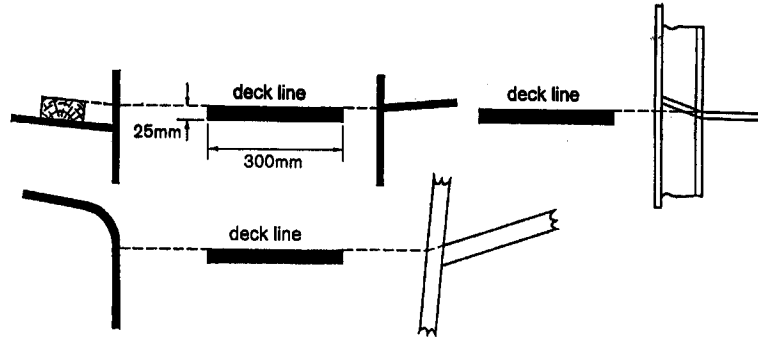

Figure 4.1 Deck line

Regulation 5

Load line mark

The load line mark shall consist of a ring 300 mm in outside diameter and 25 mm wide which is intersected by a horizontal line 450 mm in length and 25 mm in breadth, the upper edge of which passes through the centre of the ring. The centre of the ring shall be placed amidships and at a distance equal to the assigned summer freeboard measured vertically below the upper edge of the deck line (as illustrated in figure 6.1).

Regulation 6

Lines to be used with the load line mark

- (1) The lines which indicate the load line assigned in accordance with these regulations shall be horizontal lines 230 mm in length and 25 mm in breadth which extend forward of, unless expressly provided otherwise, and at right angles to, a vertical line 25 mm in breadth marked at a distance 540 mm forward of the centre of the ring (as illustrated in figure 6.1).
- (2) The following load lines shall be used:
 - (a) The Summer Load Line indicated by the upper edge of the line which passes through the centre of the ring and also by a line marked S.
 - (b) The Winter Load Line indicated by the upper edge of a line marked W.

- (c) The Winter North Atlantic Load Line indicated by the upper edge of a line marked WNA.
 - (d) The Tropical Load Line indicated by the upper edge of a line marked T.
 - (e) The Fresh Water Load Line in summer indicated by the upper edge of a line marked F. The Fresh Water Load Line in summer is marked abaft the vertical line. The difference between the Fresh Water Load Line in summer and the Summer Load Line is the allowance to be made for loading in fresh water at the other load lines.
 - (f) The Tropical Fresh Water Load Line indicated by the upper edge of a line marked TF and marked abaft the vertical line.
- (3) If timber freeboards are assigned in accordance with these regulations, the timber load lines shall be marked in addition to ordinary load lines. These lines shall be horizontal lines 230 mm in length and 25 mm in breadth which extend abaft, unless expressly provided otherwise, and are at right angles to a vertical line 25 mm in breadth marked at a distance 540 mm abaft the centre of the ring (as illustrated in figure 6.2).
- (4) The following timber load lines shall be used:
- (a) The Summer Timber Load Line indicated by the upper edge of a line marked LS.
 - (b) The Winter Timber Load Line indicated by the upper edge of a line marked LW.
 - (c) The Winter North Atlantic Timber Load Line indicated by the upper edge of a line marked LWNA.
 - (d) The Tropical Timber Load Line indicated by the upper edge of a line marked LT.
 - (e) The Fresh Water Timber Load Line in summer indicated by the upper edge of a line marked LF and marked forward of the vertical line. The difference between the Fresh Water Timber Load Line in summer and the Summer Timber Load Line is the allowance to be made for loading in fresh water at the other timber load lines.
 - (f) The Tropical Fresh Water Timber Load Line indicated by the upper edge of a line marked LTF and marked forward of the vertical line.
- (5) Where the characteristics of a ship or the nature of the ship's service or navigational limits make any of the seasonal lines inapplicable, these lines may be omitted.
- (6) Where a ship is assigned a greater than minimum freeboard so that the load line is marked at a position corresponding to, or lower than, the lowest seasonal load line assigned at minimum freeboard in accordance with the present Protocol, only the Fresh Water Load Line need be marked.
- (7) Where a Winter North Atlantic Load Line is identical with the

Winter Load Line corresponding to the same vertical line, this load line shall be marked W.

- (8) Alternative/additional load lines required by other international conventions in force may be marked at right angles to and abaft the vertical line specified in paragraph (1).

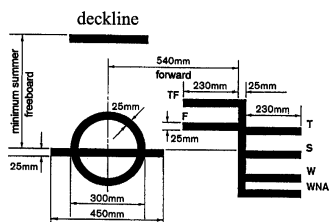

Figure 6.1 Load line mark and lines to be used with this mark

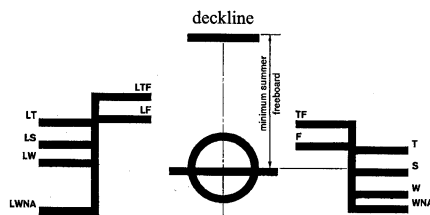

Figure 6.2 Timber load line mark and lines to be used with this mark

Regulation 7

Mark of assigning Authority

The mark of the Authority by whom the load lines are assigned may be indicated alongside the load line ring above the horizontal line which passes through the centre of the ring, or above and below it. This mark shall consist of not more than four initials to identify the Authority's name, each measuring approximately 115 mm in height and 75 mm in width.

Regulation 8

Details of marking

The ring, lines and letters shall be painted in white or yellow on a dark ground or in black on a light ground. They shall also be permanently marked on the sides of the ships to the satisfaction of the Administration. The marks shall be plainly visible and, if necessary, special arrangements shall be made for this purpose.

Regulation 9

Verification of marks

The International Load Line Certificate shall not be delivered to the ship until the officer or surveyor acting under the provisions of article 13 of the Convention has certified that the marks are correctly and permanently indicated on the ship's sides.

CHAPTER II

CONDITIONS OF ASSIGNMENT OF FREEBOARD

Regulation 10

Information to be supplied to the master

- (1) The master of every new ship shall be supplied with information to arrange for the loading and ballasting of his ship in such a way as to avoid the creation of any unacceptable stresses in the ship's structure, provided that this requirement need not apply to any particular length, design or class of ship where the Administration considers it to be unnecessary.
- (2) Information shall be provided to the master in a form that is approved by the Administration or a recognised organization. Stability information, and loading information also related to ship strength when required under paragraph (1), shall be carried on board at all times together with evidence that the information has been approved by the Administration.
- (3) A ship which is not required under the International Convention for Safety of Life at Sea in force to undergo an inclining test upon its completion shall:
 - (a) be so inclined and the actual displacement and position of the centre of gravity shall be determined for the lightship condition;
 - (b) if the Administration so approves, have its inclining test on completion dispensed with, provided basic stability data are available from the inclining test of a sister ship and it is shown to the satisfaction of the Administration that reliable stability information for the ship can be obtained from such basic data;
 - (c) if the Administration decides that the performance of an inclining test is not practicable or safe or yields inaccurate results due to the specific proportions, arrangements, strength or hull form of a ship, have the ships lightship characteristics determined by a detailed weight estimate

- confirmed by a lightweight survey;
- (d) have such information* supplied for the use of its master as is necessary to enable the master, by rapid and simple processes, to obtain accurate guidance as to the stability of the ship under all conditions likely to be encountered in normal service; and
 - (e) carry on board at all times its approved stability information together with evidence that the information has been approved by the Administration.
- (4) Where any alterations are made to a ship so as to materially affect the loading or stability information supplied to the master, amended information shall be provided. If necessary the ship shall be re-inclined.

Regulation 11

Superstructure end bulkheads

Bulkheads at exposed ends of enclosed superstructures shall be of an acceptable level of strength.

Regulation 12

Doors

- (1) All access openings in bulkheads at ends of enclosed superstructures shall be fitted with doors of steel or other equivalent material, permanently and strongly attached to the bulkhead, and framed, stiffened and fitted so that the whole structure is of equivalent strength to the un-pierced bulkhead and weathertight when closed. The means for securing these doors weathertight shall consist of gaskets and clamping devices or other equivalent means and shall be permanently attached to the bulkhead or to the doors themselves, and the doors shall be so arranged that they can be operated from both sides of the bulkhead.
- (2) Unless otherwise permitted by the Administration, doors shall open outwards to provide additional security against the impact of the sea.
- (3) Except as otherwise provided in these regulations, the height of the sills of access openings in bulkheads at ends of enclosed superstructures shall be at least 380 mm above the deck.
- (4) Portable sills shall be avoided. However, in order to facilitate

* Refer to the Code on Intact Stability for All Types of Ships covered by IMO Instruments, adopted by the Organization by resolution A.749(18), as amended.

the loading/unloading of heavy spare parts or similar, portable sills may be fitted on the following conditions:

- (a) they shall be installed before the ship leaves port; and
- (b) they shall be gasketed and fastened by closely spaced through bolts.

Regulation 13

Position of hatchways, doorways and ventilators

For the purpose of these regulations, two positions of hatchways, doorways and ventilators are defined as follows:

Position 1 – Upon exposed freeboard and raised quarter decks, and upon exposed superstructure decks situated forward of a point located a quarter of the ship's length from the forward perpendicular.

Position 2 – Upon exposed superstructure decks situated abaft a quarter of the ship's length from the forward perpendicular and located at least one standard height of superstructure above the freeboard deck.

Upon exposed superstructure decks situated forward of a point located a quarter of the ship's length from the forward perpendicular and located at least two standard heights of superstructure above the freeboard deck.

Regulation 14

Cargo and other hatchways

- (1) The construction and means for securing the weathertightness of cargo and other hatchways in position 1 and 2 shall be at least equivalent to the requirements of regulation 16, unless the application of regulation 15 to such hatchways is granted by the Administration.
- (2) Coamings and hatchway covers to exposed hatchways on decks above the superstructure deck shall comply with the requirements of the Administration.

Regulation 14-1

Hatchway coamings

- (1) The coamings of hatchways shall be of substantial construction in accordance with their position, and their height above the deck shall be at least as follows:

- (a) 600 mm if in position 1; and
- (b) 450 mm if in position 2.
- (2) In the case of hatchways which comply with regulation 16(2) through (5), the height of these coamings may be reduced, or the coamings omitted entirely, on condition that the Administration is satisfied that the safety of the ship is not thereby impaired in any sea conditions.

Regulation 15

Hatchways closed by portable covers and secured weathertight by tarpaulins and battening devices

Hatchway covers

- (1) The width of each bearing surface for hatchway covers shall be at least 65 mm.
- (2) Where covers are made of wood, the finished thickness shall be at least 60 mm in association with a span of not more than 1.5 m.
- (3) Where covers are made of mild steel the strength shall be calculated in accordance with the requirement of regulation 16(2) to (4) and the product of the maximum stress thus calculated and the factor 1.25 shall not exceed the minimum upper yield point strength of the material. They shall be so designed as to limit the deflection to not more than 0.0056 times the span under these loads.

Portable beams

- (4) Where portable beams for supporting hatchway covers are made of mild steel, the strength shall be calculated with assumed loads not less than 3.5 t/m^2 on hatchways in position 1 and not less than 2.6 t/m^2 on hatchways in position 2 and the product of the maximum stress thus calculated and the factor 1.47 shall not exceed the minimum upper yield point strength of the material. They shall be so designed as to limit the deflection to not more than 0.0044 times the span under these loads.
- (5) The assumed loads on hatchways in position 1 may be reduced to 2 t/m^2 for ships 24 m in length and shall be not less than 3.5 t/m^2 for ships 100 m in length. The corresponding loads on hatchways in position 2 may be reduced to 1.5 t/m^2 and 2.6 t/m^2 , respectively. In all cases, values at intermediate lengths shall be obtained by linear interpolation.

Pontoon covers

- (6) Where pontoon covers used in place of portable beams and covers are made of mild steel, the strength shall be calculated in accordance with the requirement of regulation 16(2) to (4) and the product of the maximum stress thus calculated and the factor 1.47 shall not exceed the minimum upper yield point strength of the material. They shall be so designed as to limit the deflection to not more than 0.0044 times the span. Mild steel plating forming the tops of covers shall be not less in thickness than 1% of the spacing of stiffeners or 6 mm if that be greater.
- (7) The strength and stiffness of covers made of materials other than mild steel shall be equivalent to those of mild steel to the satisfaction of the Administration.

Carriers or sockets

- (8) Carriers or sockets for portable beams shall be of substantial construction, and shall provide means for the efficient fitting and securing of the beams. Where rolling types of beams are used, the arrangements shall ensure that the beams remain properly in position when the hatchway is closed.

Cleats

- (9) Cleats shall be set to fit the taper of the wedges. They shall be at least 65 mm wide and spaced not more than 600 mm centre to centre; the cleats along each side or end shall be not more than 150 mm from the hatch corners.

Battens and wedges

- (10) Battens and wedges shall be efficient and in good condition. Wedges shall be of tough wood or other equivalent material. They shall have a taper of not more than 1 in 6 and shall be not less than 13 mm thick at the toes.

Tarpaulins

- (11) At least two layers of tarpaulin in good condition shall be provided for each hatchway in position 1 or 2. The tarpaulins shall be waterproof and of ample strength. They shall be of a material of at least an approved standard weight and quality.

Securing of hatchway covers

- (12) For all hatchways in position 1 or 2 steel bars or other equivalent means shall be provided in order efficiently and independently to secure each section of hatchway covers after the tarpaulins are battened down. Hatchway covers of more than 1.5 m in length shall be secured by at least two such securing appliances.

Regulation 16

Hatchways closed by weathertight covers of steel or other equivalent materials

- (1) All hatchways in position 1 and 2 shall be fitted with hatch covers of steel or other equivalent material. Except as provided in regulation 14(2), such covers shall be weathertight and fitted with gaskets and clamping devices. The means for securing and maintaining weathertightness shall be to the satisfaction of the Administration. The arrangements shall ensure that the tightness can be maintained in any sea conditions, and for this purpose tests for tightness shall be required at the initial survey, and may be required at renewal and annual surveys or at more frequent intervals.

Hatch cover minimum design loads

- (2) For ships of 100 m in length and above:
- (a) Position 1 hatch covers located in the forward quarter of the ships length shall be designed for wave loads at the forward perpendicular, calculated from the following equation:
- $$\text{Load} = 5 + (L_H - 100)a \text{ in t/m}^2$$
- where:
- L_H is L for ships of not more than 340 m but not less than 100 m in length and equal to 340 m for ships of more than 340 m in length;
- L is the length of the ship (meters), as defined in regulation 3;
- a is given in table 16.1,
- and reduced linearly to 3.5 t/m² at the end of the forward quarter's length, as shown in table 16.2. The design load used for each hatch cover panel shall be that determined at its midpoint location.
- (b) All other position 1 hatch covers shall be designed to 3.5 t/m².
- (c) Position 2 hatch covers shall be designed to 2.6 t/m².

- (d) Where a position 1 hatchway is located at least one superstructure standard height higher than the freeboard deck, it may be designed to 3.5 t/m^2 .

	a
Type B freeboard ships	0.0074
Ships assigned reduced freeboard by regulation 27(9) or (10)	0.0363

Table 16.1

- (3) For ships 24 m in length:
- Position 1 hatch covers located in the forward quarter of the ship's length shall be designed for wave loads of 2.43 t/m^2 at the forward perpendicular and reduced linearly to 2 t/m^2 at the end of the forward quarter's length as shown in table 16.2. The design load used for each hatch cover panel shall be that determined at its midpoint location.
 - All other position 1 hatch covers shall be designed to 2 t/m^2 .
 - Position 2 hatch covers shall be designed to 1.5 t/m^2 .
 - Where a position 1 hatchway is located at least one superstructure standard height higher than the freeboard deck, it may be designed to 2 t/m^2 .
- (4) For ships between 24 m and 100 m in length, and for positions between FP and $0.25L$, wave loads shall be obtained by linear interpolation of the values shown in table 16.2.

	Longitudinal position		
	FP	$0.25L$	Aft of $0.25L$
	$L > 100 \text{ m}$		
Freeboard deck	Equation in 16(2)(a)	3.5 t/m^2	3.5 t/m^2
Superstructure deck	3.5 t/m^2		2.6 t/m^2

	Longitudinal position		
	L=100 m		
Freeboard deck	5 t/m ²	3.5t/m ²	3.5 t/m ²
Superstructure deck	3.5 t/m ²		2.6 t/m ²
	L=24 m		
Freeboard deck	2.43 t/m ²	2 t/m ²	2 t/m ²
Superstructure deck	2 t/m ²		1.5 t/m ²

Table 16.2

- (5) All hatch covers shall be designed such that:
- the product of the maximum stress determined in accordance with the above loads and the factor of 1.25 does not exceed the minimum upper yield point strength of the material in tension and the critical buckling strength in compression;
 - the deflection is limited to not more than 0.0056 times the span;
 - steel plating forming the tops of covers is not less in thickness than 1% of the spacing of stiffeners or 6 mm if that be greater; and
 - an appropriate corrosion margin is incorporated.

Securing arrangements

- The means for securing and maintaining weathertightness by other means than gaskets and clamping shall be to the satisfaction of the Administration.
- Hatch covers which rest on coamings shall be located in their closed position by means capable of withstanding horizontally acting loads in any sea conditions.

Regulation 17*Machinery space openings*

- Machinery space openings in position 1 or 2 shall be properly framed and efficiently enclosed by steel casings of ample

strength, and where the casings are not protected by other structures their strength shall be specially considered. Access openings in such casings shall be fitted with doors complying with the requirements of regulation 12(1), the sills of which shall be at least 600 mm above the deck if in position 1, and at least 380 mm above the deck if in position 2.

Other openings in such casings shall be fitted with equivalent covers, permanently attached in their proper positions.

- (2) Where machinery casings are not protected by other structures, double doors (i.e. inner and outer doors complying with the requirements of regulation 12(1)) shall be required for ships assigned freeboards less than those based on table 28.2 of regulation 28. An inner sill of 230 mm in conjunction with the outer sill of 600 mm shall be provided.
- (3) Coamings of any fiddley, funnel or machinery space ventilator in an exposed position on the freeboard deck or superstructure deck shall be as high above the deck as is reasonable and practicable. In general, ventilators necessary to continuously supply the machinery space shall have coamings of sufficient height to comply with regulation 19(3), without having to fit weathertight closing appliances. Ventilators necessary to continuously supply the emergency generator room, if this is considered buoyant in the stability calculation or protecting opening leading below, shall have coamings of sufficient height to comply with regulation 19(3), without having to fit weathertight closing appliances.
- (4) Where due to ship size and arrangement this is not practicable, lesser heights for machinery space and emergency generator room ventilator coamings, fitted with weathertight closing appliances in accordance with regulation 19(4), may be permitted by the Administration in combination with other suitable arrangements to ensure an uninterrupted, adequate supply of ventilation to these spaces.
- (5) Fiddley openings shall be fitted with strong covers of steel or other equivalent material permanently attached in their proper positions and capable of being secured weathertight.

Regulation 18

Miscellaneous openings in freeboard and superstructure decks

- (1) Manholes and flush scuttles in position 1 or 2 or within superstructures other than enclosed superstructures shall be closed by substantial covers capable of being made watertight. Unless secured by closely spaced bolts, the covers shall be permanently attached.

- (2) Openings in freeboard decks other than hatchways, machinery space openings, manholes and flush scuttles shall be protected by an enclosed superstructure, or by a deckhouse or companionway of equivalent strength and weathertightness. Similarly, any such opening in an exposed superstructure deck, in the top of a deckhouse on the freeboard deck which gives access to a space below the freeboard deck or a space within an enclosed superstructure shall be protected by an efficient deckhouse or companionway. Doorways in such companionways or deckhouses that lead or give access to stairways leading below, shall be fitted with doors in accordance with regulation 12(1). Alternatively, if stairways within a deckhouse are enclosed within properly constructed companionways fitted with doors complying with regulation 12(1), the external door need not be weathertight.
- (3) Openings in the top of a deckhouse on a raised quarterdeck or superstructure of less than standard height, having a height equal to or greater than the standard quarterdeck height, shall be provided with an acceptable means of closing but need not be protected by an efficient deckhouse or companionway as defined in the regulation, provided that the height of the deckhouse is at least the standard height of a superstructure. Openings in the top of the deck house on a deck house of less than a standard superstructure height may be treated in a similar manner.
- (4) In position 1 the height above the deck of sills to the doorways in companionways shall be at least 600 mm. In position 2 it shall be at least 380 mm.
- (5) Where access is provided from the deck above as an alternative to access from the freeboard deck in accordance with regulation 3(10)(b), the height of sills into a bridge or poop shall be 380 mm. The same shall apply to deckhouses on the freeboard deck.
- (6) Where access is not provided from above, the height of the sills to doorways in deckhouses on the freeboard deck shall be 600 mm.
- (7) Where the closing appliances of access openings in superstructures and deckhouses are not in accordance with regulation 12(1), interior deck openings shall be considered exposed (i.e. situated in the open deck).

Regulation 19

Ventilators

- (1) Ventilators in position 1 or 2 to spaces below freeboard deck

or decks of enclosed superstructures shall have coamings of steel or other equivalent material, substantially constructed and efficiently connected to the deck. Ventilators in position 1 shall have coamings of a height of at least 900 mm above the deck; in position 2 the coamings shall be of a height at least 760 mm above the deck.

Where the coaming of any ventilator exceeds 900 mm in height it shall be specially supported.

- (2) Ventilators passing through superstructures other than enclosed superstructures shall have substantially constructed coamings of steel or other equivalent material at the freeboard deck.
- (3) Ventilators in position 1 the coamings of which extend to more than 4.5 m above the deck, and in position 2 the coamings of which extend to more than 2.3 m above the deck, need not be fitted with closing arrangements unless specifically required by the Administration.
- (4) Except as provided in paragraph (3), ventilator openings shall be provided with weathertight closing appliances of steel or other equivalent material. In ships of not more than 100 m in length the closing appliances shall be permanently attached; where not so provided in other ships, they shall be conveniently stowed near the ventilators to which they are to be fitted.
- (5) In exposed locations, the height of coamings may be increased to the satisfaction of the Administration.

Regulation 20

Air pipes

- (1) Where air pipes to ballast and other tanks extend above the freeboard or superstructure decks, the exposed parts of the pipes shall be of substantial construction; the height from the deck to the point where water may have access below shall be at least 760 mm on the freeboard deck and 450 mm on the superstructure deck.
- (2) Where these heights may interfere with the working of the ship, a lower height may be approved, provided that the Administration is satisfied that the closing arrangements and other circumstances justify a lower height.
- (3) Air pipes shall be provided with automatic closing devices.
- (4) Pressure-vacuum valves (PV valves) may be accepted on tankers.

Regulation 21

Cargo ports and other similar openings

- (1) Cargo ports and other similar openings in the sides of ships below the freeboard deck shall be fitted with doors so designed as to ensure the same watertightness and structural integrity as the surrounding shell plating. Unless otherwise granted by the Administration, these opening shall open outwards. The number of such openings shall be the minimum compatible with the design and proper working of the ship.
- (2) Unless otherwise permitted by the Administration, the lower edge of openings referred to in paragraph (1) shall not be below a line drawn parallel to the freeboard deck at side, which is at its lowest point at least 230 mm above the upper edge of the uppermost load line.
- (3) Where it is permitted to arrange cargo ports and other similar openings with their lower edge below the line specified in paragraph (2), additional features shall be fitted to maintain the watertight integrity.
- (4) The fitting of a second door of equivalent strength and watertightness is one acceptable arrangement. A leakage detection device shall be provided in the compartment between the two doors. Drainage of this compartment to the bilges, controlled by a readily accessible screw down valve, shall be arranged. The outer door shall open outwards.
- (5) Arrangements for bow doors and their inner doors, side doors and stern doors and their securings shall be in compliance with the requirements of a recognised organization, or with the applicable national standards of the Administration which provide an equivalent level of safety.

Regulation 22

Scuppers, inlets and discharges

- (1) (a) Discharges led through the shell either from spaces below the freeboard deck or from within superstructures and deckhouses on the freeboard deck fitted with doors complying with the requirements of regulation 12 shall, except as provided in paragraph (2), be fitted with efficient and accessible means for preventing water from passing in-board. Normally each separate discharge shall have one automatic non-return valve with a positive means of closing it from a position above the freeboard deck. Where the

inboard end of the discharge pipe is located at least 0.01L above the Summer Load Line, the discharge may have two automatic non-return valves without positive means of closing. Where that vertical distance exceeds 0.02L, a single automatic non-return valve without positive means of closing may be accepted. The means for operating the positive action valve shall be readily accessible and provided with an indicator showing whether the valve is open or closed.

- (b) One automatic non-return valve and one sluice valve controlled from above the freeboard deck instead of one automatic non-return valve with a positive means of closing from a position above the freeboard deck, is acceptable.
- (c) Where two automatic non-return valves are required, the inboard valve shall always be accessible for examination under service conditions (i.e., the inboard valve shall be above the level of the Tropical Load Line). If this is not practicable, the inboard valve need not be located above the Tropical Load Line, provided that a locally controlled sluice valve is fitted between the two automatic non-return valves.
- (d) Where sanitary discharges and scuppers lead overboard through the shell in way of machinery spaces, a locally operated positive closing valve at the shell, together with a non-return valve inboard, is acceptable. The controls of the valves shall be in an easily accessible position.
- (e) The position of the inboard end of discharges shall be related to the Summer Timber Load Line when a timber freeboard is assigned.
- (f) The requirements for non-return valves are applicable only to those discharges which remain open during the normal operation of a ship. For discharges which are to be kept closed at sea, a single screw down valve operated from the deck is acceptable.
- (g) Table 22.1 provides the acceptable arrangements of scuppers, inlets and discharges.

Discharges coming from enclosed spaces below the freeboard deck or on the freeboard deck		Discharges coming from other spaces	
<p>General requirement Reg. 22(1) where inboard end $\leq 0.01L$ above SWL</p> <p>Discharges through machinery space</p> <p>Alternatives (Reg. 22(1)) where inboard end $> 0.02L$ above SWL</p>	<p>outboard end $> 450\text{mm}$ below FB deck or $\leq 600\text{mm}$ above SWL. Reg. 22(4)</p> <p>otherwise Reg. 22(5)</p>	<p>General requirement Reg. 22(1) where inboard end $\leq 0.01L$ above SWL</p> <p>Discharges through machinery space</p> <p>Alternatives (Reg. 22(1)) where inboard end $> 0.02L$ above SWL</p>	<p>outboard end $> 450\text{mm}$ below FB deck or $\leq 600\text{mm}$ above SWL. Reg. 22(4)</p> <p>otherwise Reg. 22(5)</p>
<p>Superstructure or Deckhouse Deck</p>			
<p>FB Deck</p>			
<p>SWL</p>			
<p>Symbols:</p> <ul style="list-style-type: none"> ∇ inboard end of pipes \swarrow outboard end of pipes \searrow pipes terminating on the open deck 	<ul style="list-style-type: none"> \emptyset non return valve without positive means of closing \emptyset non return valve with positive means of closing controlled locally \times valve controlled locally 	<ul style="list-style-type: none"> \perp remote control $$ normal thickness $$ substantial thickness 	<ul style="list-style-type: none"> \perp remote control $$ normal thickness $$ substantial thickness

Table 22.1

- (2) Scuppers led through the shell from enclosed superstructures used for the carriage of cargo shall be permitted only where the edge of the freeboard deck is not immersed when the ship heels 5° either way. In other cases the drainage shall be led

- inboard in accordance with the requirements of the International Convention for the Safety of Life at Sea in force.
- (3) In manned machinery spaces, main and auxiliary sea inlets and discharges in connection with the operation of machinery may be controlled locally. The controls shall be readily accessible and shall be provided with indicators showing whether the valves are open or closed.
 - (4) Scuppers and discharge pipes originating at any level and penetrating the shell either more than 450 mm below the freeboard deck or less than 600 mm above the Summer Load Line shall be provided with a non-return valve at the shell. This valve, unless required by paragraph (2), may be omitted if the piping is of substantial thickness (see paragraph (7) below).
 - (5) Scuppers leading from superstructures or deckhouses not fitted with doors complying with the requirements of regulation 12 shall be led overboard.
 - (6) All shell fittings and the valves required by this regulation shall be of steel, bronze or other approved ductile material. Valves of ordinary cast iron or similar material are not acceptable. All pipes to which this regulation refers shall be of steel or other equivalent material to the satisfaction of the Administration.
 - (7) Scupper and discharge pipes:
 - (a) For scupper and discharge pipes, where substantial thickness is not required:
 - (i) for pipes having an external diameter equal to or less than 155 mm, the thickness shall not be less than 4.5 mm;
 - (ii) for pipes having an external diameter equal to or more than 230 mm, the thickness shall not be less than 6 mm.
Intermediate sizes shall be determined by linear interpolation.
 - (b) For scupper and discharge pipes, where substantial thickness is required:
 - (i) for pipes having an external diameter equal to or less than 80 mm, the thickness shall not be less than 7 mm;
 - (ii) for pipes having an external diameter of 180 mm, the thickness shall not be less than 10 mm;
 - (iii) for pipes having an external diameter equal to or more than 220 mm, the thickness shall not be less than 12.5 mm.
Intermediate sizes shall be determined by linear interpolation.

Regulation 22-1

Garbage chutes

- (1) Two gate valves controlled from the working deck of the chute instead of the non-return valve with a positive means of closing from a position above the freeboard deck which comply with the following requirements are acceptable:
 - (a) the lower gate valve shall be controlled from a position above the freeboard deck. An interlock system between the two valves shall be arranged;
 - (b) the inboard end shall be located above the waterline formed by an 8.5° heel to port or starboard at a draft corresponding to the assigned summer freeboard, but not less than 1,000 mm above the summer waterline. Where the inboard end exceeds 0.01L above the summer waterline, valve control from the freeboard deck is not required, provided the inboard gate valve is always accessible under service conditions; and
 - (c) alternatively, the upper and lower gate valves may be replaced by a hinged weathertight cover at the inboard end of the chute together with a discharge flap. The cover and flap shall be arranged with an interlock so that the discharge flap cannot be operated until the hopper cover is closed.
- (2) The entire chute, including the cover, shall be constructed of material of substantial thickness.
- (3) The controls for the gate valves and/or hinged covers shall be clearly marked: "Keep closed when not in use".
- (4) Where the inboard end of the chute is below the freeboard deck of a passenger ship or the equilibrium waterlines of a cargo ship to which damage stability requirements apply, then:
 - (a) the inboard end hinged cover/valve shall be watertight;
 - (b) the valve shall be a screw-down non-return valve fitted in an easily accessible position above the deepest load line; and
 - (c) the screw-down non-return valve shall be controlled from a position above the bulkhead deck and provided with open/closed indicators. The valve control shall be clearly marked: "Keep closed when not in use".

Regulation 22-2

Spurling pipes and cable lockers

- (1) Spurling pipes and cable lockers shall be watertight up to the deck exposed to weather.

- (2) Where means of access are provided, they shall be closed by a substantial cover and secured by closely spaced bolts.
- (3) Spurling pipes through which anchor cables are led shall be provided with permanently attached closing appliances to minimize water ingress.

Regulation 23

Side scuttles, windows and skylights

- (1) Side scuttles and windows, together with their glasses, deadlights and storm covers*, if fitted, shall be of an approved design and substantial construction.
Non-metallic frames are not acceptable.
- (2) Side scuttles are defined as being round or oval openings with an area not exceeding 0.16 m². Round or oval openings having areas exceeding 0.16 m² shall be treated as windows.
- (3) Windows are defined as being rectangular openings generally, having a radius at each corner relative to the window size and round or oval openings with an area exceeding 0.16 m².
- (4) Side scuttles to the following spaces shall be fitted with hinged inside deadlights:
 - (a) spaces below freeboard deck;
 - (b) spaces within the first tier of enclosed superstructures; and
 - (c) first tier deckhouses on the freeboard deck protecting openings leading below or considered buoyant in stability calculations.

Deadlights shall be capable of being closed and secured watertight if fitted below the freeboard deck and weathertight if fitted above.
- (5) Side scuttles shall not be fitted in such a position that their sills are below a line drawn parallel to the freeboard deck at side and having its lowest point 2.5% of the breadth (B), or 500 mm, whichever is the greatest distance, above the Summer Load Line (or Timber Summer Load Line if assigned).
- (6) If the required damage stability calculations indicate that the side scuttles would become immersed at any intermediate stage of flooding or the final equilibrium waterline, they shall be of the non-opening type.
- (7) Windows shall not be fitted in the following locations:
 - (a) below the freeboard deck;
 - (b) in the first tier end bulkheads or sides of enclosed superstructures; or

* Deadlights are fitted to the inside of windows and side scuttles, while storm covers are fitted to the outside of windows, where accessible, and may be hinged or portable.

- (c) in first tier deckhouses that are considered buoyant in the stability calculations.
- (8) Side scuttles and windows at the side shell in the second tier shall be provided with hinged inside deadlights capable of being closed and secured weathertight if the superstructure protects direct access to an opening leading below or is considered buoyant in the stability calculations.
- (9) Side scuttles and windows in side bulkheads set inboard from the side shell in the second tier which protect direct access below to spaces listed in paragraph (4) shall be provided with either hinged inside deadlights or, where they are accessible, permanently attached external storm covers which are capable of being closed and secured weathertight.
- (10) Cabin bulkheads and doors in the second tier and above separating side scuttles and windows from a direct access leading below or the second tier considered buoyant in the stability calculations may be accepted in place of deadlights or storm covers fitted to the side scuttles and windows.
- (11) Deckhouses situated on a raised quarter deck or on the deck of a superstructure of less than standard height may be regarded as being in the second tier as far as the requirements for deadlights are concerned, provided that the height of the raised quarter deck or superstructure is equal to or greater than the standard quarter deck height.
- (12) Fixed or opening skylights shall have a glass thickness appropriate to their size and position as required for side scuttles and windows. Skylight glasses in any position shall be protected from mechanical damage and, where fitted in position 1 or 2, shall be provided with permanently attached deadlights or storm covers.

Regulation 24

Freeing ports

- (1) (a) Where bulwarks on the weather portions of freeboard or superstructure decks form wells, ample provision shall be made for rapidly freeing the decks of water and for draining them.
- (b) Except as provided in paragraphs (1)(c) and (2), the minimum freeing port area (A) on each side of the ship for each well on the freeboard deck shall be that given by the following formulae in cases where the sheer in way of the well is standard or greater than standard.
The minimum area for each well on superstructure decks

shall be one-half of the area given by the following formulae:

Where the length of bulwark (l) in the well is 20 m or less:

$$A = 0.7 + 0.035 l m^2;$$

where l exceeds 20 m:

$$A = 0.07 l m^2.$$

l need in no case be taken as greater than $0.7L$.

If the bulwark is more than 1.2 m in average height, the required area shall be increased by $0.004 m^2$ per metre of length of well for each 0.1 m difference in height. If the bulwark is less than 0.9 m in average height, the required area may be decreased by $0.004 m^2$ per m of length of well for each 0.1 m difference in height.

- (c) In ships with no sheer, the area calculated according to paragraph (b) shall be increased by 50%. Where the sheer is less than the standard, the percentage shall be obtained by linear interpolation.
 - (d) On a flush deck ship with a deckhouse amidships having a breadth of at least 80% of the beam of the ship and the passageways along the side of the ship not exceeding 1.5 m in width, two wells are formed. Each shall be given the required freeing port area based upon the length of each well.
 - (e) Where a screen bulkhead is fitted completely across the ship at the forward end of a midship deckhouse, the exposed deck is divided into two wells and there is no limitation on the breadth of the deckhouse.
 - (f) Wells on raised quarterdecks shall be treated as being on freeboard decks.
 - (g) Gutter bars greater than 300 mm in height fitted around the weather decks of tankers in way of cargo manifolds and cargo piping shall be treated as bulwarks. Freeing ports shall be arranged in accordance with this regulation. Closures attached to the freeing ports for use during loading and discharge operations are to be arranged in such a way that jamming cannot occur while at sea.
- (2) Where a ship fitted with a trunk does not comply with the requirements of regulation 36(1)(e) or where continuous or substantially continuous hatchway side coamings are fitted between detached superstructures, the minimum area of the freeing port openings shall be calculated from the following table:

Breadth of hatchway or trunk in relation to the breadth of ship	Area of freeing ports in relation to the total area of the bulwarks
40% or less	20%
75% or more	10%

The area of freeing ports at intermediate breadths shall be obtained by linear interpolation.

- (3) The effectiveness of the freeing area in bulwarks required by paragraph (1) depends on the free flow area across the deck of a ship.

The free flow area on deck is the net area of gaps between hatchways, and between hatchways and superstructures and deckhouses up to the actual height of the bulwark.

The freeing port area in bulwarks shall be assessed in relation to the net free flow area as follows:

- (a) If the free flow area is not less than the freeing area calculated from paragraph (2) as if the hatchway coamings were continuous, then the minimum freeing port area calculated from paragraph (1) shall be deemed sufficient.
- (b) If the free flow area is equal to, or less than the area calculated from paragraph (1), the minimum freeing area in the bulwarks shall be determined from paragraph (2).
- (c) If the free flow area is smaller than calculated from paragraph (2), but greater than calculated from paragraph (1), the minimum freeing area in the bulwark shall be determined from the following formula:

$$F = F_1 + F_2 - f_p \text{ (m}^2\text{)}$$

where:

F_1 is the minimum freeing area calculated from paragraph (1);

F_2 is the minimum freeing area calculated from paragraph (2); and

f_p is the total net area of passages and gaps between hatch ends and superstructures or deckhouses up to the actual height of bulwark.

- (4) In ships having superstructures on the freeboard deck or superstructure decks, which are open at either or both ends to wells formed by bulwarks on the open decks, adequate provision for freeing the open spaces within the superstructures shall be provided.

The minimum freeing port area on each side of the ship for the open superstructure (A_s) and for the open well (A_w), shall be calculated in accordance with the following procedure:

- (a) Determine the total well length (l_t) equal to the sum of the length of the open deck enclosed by bulwarks (l_w) and the length of the common space within the open superstructure (l_s).
- (b) To determine A_s :
- (i) calculate the freeing port area (A) required for an open well of length l_t in accordance with paragraph (1) with standard height bulwark assumed;
 - (ii) multiply by a factor of 1.5 to correct for the absence of sheer, if applicable, in accordance with paragraph (1)(c);
 - (iii) multiply by the factor (b_o/l_t) to adjust the freeing port area for the breadth (b_o) of the openings in the end bulkhead of the enclosed superstructure;
 - (iv) to adjust the freeing port area for that part of the entire length of the well which is enclosed by the open superstructure, multiply by the factor:

$$1 - (l_w/l_t)^2$$
 where l_w and l_t are defined in paragraph (4)(a);
 - (v) to adjust the freeing port area for the distance of the well deck above the freeboard deck, for decks located more than $0.5 h_s$ above the freeboard deck, multiply by the factor:

$$0.5 (h_s/h_w)$$
 where h_w is the distance of the well deck above the freeboard deck and h_s is one standard superstructure height.
- (c) To determine A_w :
- (i) the freeing port area for the open well (A_w) shall be calculated in accordance with paragraph (b)(i), using l_w to calculate a nominal freeing port area (A'), and then adjusted for the actual height of the bulwark (h_b) by the application of one of the following area corrections, whichever is applicable:
 for bulwarks greater than 1.2 m in height:

$$A_c = l_w((h_b - 1.2)/0.10)(0.004) \text{ m}^2;$$
 for bulwarks less than 0.9 m in height:

$$A_c = l_w((h_b - 0.9)/0.10)(0.004) \text{ m}^2;$$
 for bulwarks between 1.2 m and 0.9 m in height there is no correction (i.e. $A_c = 0$);
 - (ii) the corrected freeing port area ($A_w = A' + A_c$) shall then be adjusted for absence of sheer, if applicable, and height above freeboard deck as in paragraphs (b)(ii) and (b)(v), using h_s and h_w .
- (d) The resulting freeing port areas for the open superstructure (A_s) and for the open well (A_w) shall be provided along each side of the open space covered by the open super-

- structure and each side of the open well, respectively.
- (e) The above relationships are summarised by the following equations, assuming l_t , the sum of l_w and l_s , is greater than 20 m:
 freeing port area A_w for the open well:
 $A_w = (0.07l_w + A_c)$ (sheer correction) $(0.5h_s/h_w)$;
 freeing port area A_s for the open superstructure:
 $A_s = (0.07l_t)$ (sheer correction) $(b/l_t (1 - (l_w/l_t)^2) (0.5h_s/h_w))$;
 where l_t is 20 m or less, the basic freeing port area is $A = 0.7 + 0.035l_t$ in accordance with paragraph (1).
- (5) The lower edges of freeing ports shall be as near the deck as practicable. Two-thirds of the freeing port area required shall be provided in the half of the well nearest the lowest point of the sheer curve. One third of the freeing port area required shall be evenly spread along the remaining length of the well. With zero or little sheer on the exposed freeboard deck or an exposed superstructure deck the freeing port area shall be evenly spread along the length of the well.
- (6) All freeing port openings in the bulwarks shall be protected by rails or bars spaced approximately 230 mm apart. If shutters are fitted to freeing ports, ample clearance shall be provided to prevent jamming. Hinges shall have pins or bearings of non-corrodible material. Shutters shall not be fitted with securing appliances.

Regulation 25

Protection of the crew

- (1) The deckhouses used for the accommodation of the crew shall be constructed to an acceptable level of strength.
- (2) Guard rails or bulwarks shall be fitted around all exposed decks. The height of the bulwarks or guard rails shall be at least 1 m from the deck, provided that where this height would interfere with the normal operation of the ship, a lesser height may be approved, if the Administration is satisfied that adequate protection is provided.
- (3) Guard rails fitted on superstructure and freeboard decks shall have at least three courses. The opening below the lowest course of the guard rails shall not exceed 230 mm. The other courses shall be not more than 380 mm apart. In the case of ships with rounded gunwales the guard rail supports shall be placed on the flat of the deck. In other locations, guardrails with at least two courses shall be fitted.
 Guard rails shall comply with the following provisions:

- (a) fixed, removable or hinged stanchions shall be fitted about 1.5 m apart.
Removable or hinged stanchions shall be capable of being locked in the upright position;
 - (b) at least every third stanchion shall be supported by a bracket or stay;
 - (c) where necessary for the normal operation of the ship, steel wire ropes may be accepted in lieu of guard rails. Wires shall be made taut by means of turnbuckles; and
 - (d) where necessary for the normal operation of the ship, chains fitted between two fixed stanchions and/or bulwarks are acceptable in lieu of guard rails.
- (4) Satisfactory means for safe passage required by regulation 25-1 (in the form of guard rails, lifelines, gangways or under-deck passages, etc.) shall be provided for the protection of the crew in getting to and from their quarters, the machinery space and any other spaces used in the essential operation of the ship.
- (5) Deck cargo carried on any ship shall be so stowed that any opening which is in way of the cargo and which gives access to and from the crew's quarters, the machinery space and all other parts used in the essential operation of the ship can be closed and secured against water ingress. Protection for the crew in the form of guard rails or lifelines shall be provided above the deck cargo if there is no convenient passage on or below the deck of the ship.

Regulation 25-1

Means for safe passage of crew

(1) The safe passage of crew shall be provided by at least one of the means prescribed in table 25-1-1.1 below:

Type of ship	Locations of access in ship	Assigned summer freeboard	Acceptable arrangement according to type of freeboard assigned***			
			Type 'A'	Type 'B-100'	Type 'B-60'	Type 'B' and 'B+'
All ships other than oil tankers*, chemical tankers* and gas carriers*	1.1 Access to midship quarters	≤3,000 mm	(a) (b) (c)	(a) (b) (c)	(a) (b) (c)(i) (c) (f)(i)	(a) (b) (c)(i) (c)(ii) (c)(iv)
	1.1.1 Between poop and bridge, or 1.1.2 Between poop and deckhouse containing living accommodation or navigating equipment, or both.		(a) (b) (c)	(a) (b) (c)	(a) (b) (c)(i) (c)(ii) (c) (f)(i) (f)(ii)	(d)(i) (d)(ii) (d)(iii) (e) (f)(i) (f)(ii) (f)(iv)
	1.2 Access to ends	≤ 3,000 mm	(a) (b) (c)(i) (c) (f)(i)	(a) (b) (c)(i) (c)(ii) (c) (f)(i) (f)(ii)	(a) (b) (c)(i) (c)(ii) (c) (f)(i) (f)(ii)	
	1.2.1 Between poop and bow (if there is no bridge). 1.2.2 Between bridge and bow, or 1.2.3 Between a deckhouse containing living accommodation or navigating equipment, or both, and bow, or 1.2.4 In the case of a flush deck ship, between crew accommodation and the forward and after ends of ship.	≤ 3,000 mm	(a) (b) (c)(i) (d)(i) (c) (f)(i)	(a) (b) (c)(i) (c)(ii) (c)(i) (d)(ii) (d)(i) (f)(i) (f)(ii)	(a) (b) (c)(i) (c)(ii) (c)(iv) (d)(i) (d)(ii) (d)(iii) (c) (f)(i) (f)(ii) (f)(iv)	
Oil tankers*, chemical tankers* and gas carriers*	2.1 Access to bow	≤ (A _r + H ₄)**			(a) (c) (f)(i) (f)(v)	
	2.1.1 Between poop and how or 2.1.2 Between a deckhouse containing living accommodation or navigating equipment, or both, and bow, or 2.1.3 In the case of a flush deck ship, between crew accommodation and the forward ends of ship				(a) (c) (f)(i) (f)(ii)	
	2.2 Access to after end In the case of a flush deck ship, between crew accommodation and the after end of ship.					As required in 1.2.4 for other types of ships

Table 25-1-1

* Oil tankers, chemical tankers and gas carriers as defined in regulations II-1/2.12, VII/8.2 and VII/11.2, respectively, of the International Convention for the Safety of Life at Sea, 1974, as amended.

** A_r: the minimum summer freeboard calculated as type 'A' ship regardless of the type freeboard actually assigned.

H₄: the standard height of superstructure as defined in regulation 33.

*** Arrangements (a)-(f) are described in paragraph (2) below. Locations (i)-(v) are described in paragraph (3) below.

- (2) Acceptable arrangements referred to in table 25-1.1 are defined as follows:
- (a) A well lighted and ventilated under-deck passageway (with a clear opening of at least 0.8 m wide and 2 m high), as close as practicable to the freeboard deck, connecting and providing access to the locations in question.
 - (b) A permanent and efficiently constructed gangway, fitted at or above the level of the superstructure deck, on or as near as practicable to the centre line of the ship, providing a continuous platform at least 0.6 m in width and a non-slip surface and with guard rails extending on each side throughout its length. Guard rails shall be at least 1 m high with three courses and constructed as required in regulation 25(3). A foot-stop shall be provided.
 - (c) A permanent walkway at least 0.6 m in width, fitted at freeboard deck level and consisting of two rows of guard rails with stanchions spaced not more than 3 m. The number of courses of rails and their spacing shall be in accordance with regulation 25(3). On type "B" ships, hatchway coamings not less than 0.6 m in height may be accepted as forming one side of the walkway, provided that two rows of guard rails are fitted between the hatchways.
 - (d) A wire rope lifeline not less than 10 mm in diameter, supported by stanchions not more than 10 m apart, or a single hand rail or wire rope attached to hatch coamings, continued and supported between hatchways.
 - (e) A permanent gangway that is:
 - (i) located at or above the level of the superstructure deck;
 - (ii) located on or as near as practicable to the centre line of the ship;
 - (iii) located so as not to hinder easy access across the working areas of the deck;
 - (iv) providing a continuous platform at least 1 m in width;
 - (v) constructed of fire resistant and non-slip material;
 - (vi) fitted with guard rails extending on each side throughout its length;
guard rails shall be at least 1 m high with courses as required by regulation 25(3) and supported by stanchions spaced not more than 1.5 m apart;
 - (vii) provided with a foot-stop on each side;
 - (viii) having openings, with ladders where appropriate, to and from the deck. Openings shall not be more than 40 m apart; and
 - (ix) having shelters set in way of the gangway at intervals not exceeding 45 m if the length of the exposed deck to be traversed exceeds 70 m. Every such shelter shall

- be capable of accommodating at least one person and be so constructed as to afford weather protection on the forward, port and starboard sides.
- (f) A permanent walkway located at the freeboard deck level, on or as near as practicable to the centre line of the ship, having the same specifications as those for a permanent gangway listed in (e), except for foot-stops. On type "B" ships (certified for the carriage of liquids in bulk) with a combined height of hatch coaming and fitted hatch cover of not less than 1 m in height, the hatchway coamings may be accepted as forming one side of the walkway, provided that two rows of guard rails are fitted between the hatchways.
- (3) Permitted transverse locations for arrangements in paragraphs (2)(c), (d) and (f) above, where appropriate:
- (i) at or near the centre line of the ship; or fitted on hatchways at or near the centre line of the ship;
 - (ii) fitted on each side of the ship;
 - (iii) fitted on one side of the ship, provision being made for fitting on either side;
 - (iv) fitted on one side of the ship only;
 - (v) fitted on each side of the hatchways, as near to the centre line as practicable.
- (4) (a) Where wire ropes are fitted, turnbuckles shall be provided to ensure their tautness.
- (b) Where necessary for the normal operation of the ship, steel wire ropes may be accepted in lieu of guard rails.
- (c) Where necessary for the normal operation of the ship, chains fitted between two fixed stanchions are acceptable in lieu of guard rails.
- (d) Where stanchions are fitted, every third stanchion shall be supported by a bracket or stay.
- (e) Removable or hinged stanchions shall be capable of being locked in the upright position.
- (f) A means of passage over obstructions such as pipes or other fittings of a permanent nature, shall be provided.
- (g) Generally, the width of the gangway or deck-level walkway should not exceed 1.5 m.
- (5) For tankers less than 100 m in length, the minimum width of the gangway platform or deck-level walkway fitted in accordance with paragraphs (2)(e) or (f) above, respectively, may be reduced to 0.6 m.

Regulation 26

*Special conditions of assignment for type "A" ships***Machinery casings**

- (1) Machinery casings on type "A" ships, as defined in regulation 27, shall be protected by one of the following arrangements:
 - (a) an enclosed poop or bridge of at least standard height; or
 - (b) a deckhouse of equal height and equivalent strength.
- (2) Machinery casings may, however, be exposed if there are no openings giving direct access from the freeboard deck to the machinery space. A door complying with the requirements of regulation 12 is acceptable in the machinery casing, provided that it leads to a space or passageway which is as strongly constructed as the casing and is separated from the stairway to the engine-room by a second weathertight door of steel or other equivalent material.

Gangway and access

- (3) A fore and aft permanent gangway, constructed in accordance with the provisions of regulation 25-1(2)(e), shall be fitted on type "A" ships at the level of the superstructure deck between the poop and the midship bridge or deckhouse where fitted. The arrangement contained in regulation 25-1(2)(a) is considered an equivalent means of access to carry out the purpose of the gangway.
- (4) Safe access from the gangway level shall be available between separate crew accommodations and also between crew accommodations and the machinery space.

Hatchways

- (5) Exposed hatchways on the freeboard and forecastle decks or on the tops of expansion trunks on type "A" ships shall be provided with efficient watertight covers of steel or other equivalent material.

Freeing arrangements

- (6) Type "A" ships with bulwarks shall have open rails fitted for at least half the length of the weather deck or other equivalent freeing arrangements. A freeing port area, in the lower part of the bulwarks, of 33% of the total area of the bulwarks, is an acceptable equivalent freeing arrangement. The upper edge of the sheer strake shall be kept as low as practicable.

- (7) Where superstructures are connected by trunks, open rails shall be fitted for the whole length of the exposed parts of the freeboard deck.

CHAPTER III

FREEBOARDS

Regulation 27

Types of ships

- (1) For the purposes of freeboard computation, ships shall be divided into type "A" and type "B".

Type "A" ships

- (2) A type "A" ship is a ship which:
- (a) is designed to carry only liquid cargoes in bulk;
 - (b) has a high integrity of the exposed deck with only small access openings to cargo compartments, closed by watertight gasketed covers of steel or equivalent material; and
 - (c) has low permeability of loaded cargo compartments.
- (3) A type "A" ship, if over 150 m in length, to which a freeboard less than type "B" has been assigned, when loaded in accordance with the requirements of paragraph (11), shall be able to withstand the flooding of any compartment or compartments, with an assumed permeability of 0.95, consequent upon the damage assumptions specified in paragraph (12), and shall remain afloat in a satisfactory condition of equilibrium, as specified in paragraph (13). In such a ship, the machinery space shall be treated as a floodable compartment, but with a permeability of 0.85.
- (4) A type "A" ship shall be assigned a freeboard not less than that given in table 28.1.

Type "B" ships

- (5) All ships which do not come within the provisions regarding type "A" ships in paragraphs (2) and (3) shall be considered as type "B" ships.
- (6) Type "B" ships, which in position 1 have hatch covers which are permitted by the Administration to comply with the requirements of regulation 15 (other than paragraph (6)) or which are fitted with securing arrangements accepted under the provisions of regulation 16(6), shall be assigned freeboards

based upon the values given in table 28.2, increased by the values given in table 27.1:

Freeboard increase over tabular freeboard for type “B” ships, for ships with hatch covers complying with the provisions of regulation 15 (other than paragraph (6))

Length of ship (m)	Freeboard increase (mm)	Length of ship (m)	Freeboard increase (mm)	Length of ship (m)	Freeboard increase (mm)
108 and below	50	139	175	170	290
109	52	140	181	171	292
110	55	141	186	172	294
111	57	142	191	173	297
112	59	143	196	174	299
113	62	144	201	175	301
114	64	145	206	176	304
115	68	146	210	177	306
116	70	147	215	178	308
117	73	148	219	179	311
118	76	149	224	180	313
119	80	150	228	181	315
120	84	151	232	182	318
121	87	152	236	183	320
122	91	153	240	184	322
123	95	154	244	185	325
124	99	155	247	186	327
125	103	156	251	187	329
126	108	157	254	188	332
127	112	158	258	189	334
128	116	159	261	190	336
129	121	160	264	191	339
130	126	161	267	192	341
131	131	162	270	193	343
132	136	163	273	194	346
133	142	164	275	195	348
134	147	165	278	196	350
135	153	166	280	197	353
136	159	167	283	198	355
137	164	168	285	199	357
138	170	169	287	200	358

Freeboards at intermediate lengths of ship shall be obtained by linear interpolation. Ships above 200 m in length shall be dealt with by the Administration.

Table 27.1

- (7) Type “B” ships, which in position 1 have hatchways fitted with hatch covers complying with the requirements of regula-

tion 16(2) through (5), shall, except as provided in paragraphs (8) to (13) inclusive, be assigned freeboards based on table 28.2.

- (8) Any type "B" ship of over 100 m in length may be assigned freeboards less than those required under paragraph (7), provided that, in relation to the amount of reduction granted, the Administration is satisfied that:
- (a) the measures provided for the protection of the crew are adequate;
 - (b) the freeing arrangements are adequate;
 - (c) the covers in position 1 and 2 comply with the provisions of regulation 16(1) through (5) and (7); and
 - (d) the ship, when loaded in accordance with the requirements of paragraph (11), shall be able to withstand the flooding of any compartment or compartments, with an assumed permeability of 0.95, consequent upon the damage assumptions specified in paragraph (12), and shall remain afloat in a satisfactory condition of equilibrium, as specified in paragraph (13). In such a ship, if over 150 m in length, the machinery space shall be treated as a floodable compartment, but with a permeability of 0.85.
- (9) In calculating the freeboards for type "B" ships which comply with the requirements of paragraphs (8), (11), (12) and (13), the values from table 28.2 shall not be reduced by more than 60% of the difference between the tabular values in tables 28.1 and 28.2 for the appropriate ship lengths.
- (10) (a) The reduction in tabular freeboard allowed under paragraph (9) may be increased up to the total difference between the values in table 28.1 and those in table 28.2 on condition that the ship complies with the requirements of:
- (i) regulation 26, other than paragraph (5), as if it were a type "A" ship;
 - (ii) paragraphs (8), (11) and (13); and
 - (iii) paragraph (12), provided that throughout the length of the ship any one transverse bulkhead will be assumed to be damaged, such that two adjacent fore and aft compartments shall be flooded simultaneously, except that such damage will not apply to the boundary bulkheads of a machinery space.
- (b) In such a ship, if over 150 m in length, the machinery space shall be treated as a floodable compartment, but with a permeability of 0.85.

Initial condition of loading

- (11) The initial condition of loading before flooding shall be determined as follows:
- (a) The ship is loaded to its Summer Load Waterline on an imaginary even keel.
 - (b) When calculating the vertical centre of gravity, the following principles apply:
 - (i) homogeneous cargo is carried;
 - (ii) all cargo compartments, except those referred to under subparagraph (iii), but including compartments intended to be partially filled, shall be considered fully loaded except that in the case of fluid cargoes each compartment shall be treated as 98% full;
 - (iii) if the ship is intended to operate at its Summer Load Waterline with empty compartments, such compartments shall be considered empty, provided the height of the centre of gravity so calculated is not less than as calculated under subparagraph (ii);
 - (iv) 50% of the individual total capacity of all tanks and spaces fitted to contain consumable liquids and stores is allowed for. It shall be assumed that for each type of liquid at least one transverse pair or a single centreline tank has maximum free surface, and the tank or combination of tanks to be taken into account shall be those where the effect of free surfaces is the greatest; in each tank the centre of gravity of the contents shall be taken at the centre of volume of the tank. The remaining tanks shall be assumed either completely empty or completely filled, and the distribution of consumable liquids between these tanks shall be effected so as to obtain the greatest possible height above the keel for the centre of gravity;
 - (v) at an angle of heel of not more than 5° in each compartment containing liquids, as prescribed in subparagraph (ii), except that in the case of compartments containing consumable fluids, as prescribed in subparagraph (iv), the maximum free surface effect shall be taken into account. Alternatively, the actual free surface effects may be used, provided the methods of calculation are acceptable to the Administration;
 - (vi) weights shall be calculated on the basis of the following values for specific gravities:

salt water	1.025
fresh water	1.000
oil fuel	0.950
diesel oil	0.900
lubricating oil	0.900.

Damage assumptions

- (12) The following principles regarding the character of the assumed damage apply:
- (a) The vertical extent of damage in all cases is assumed to be from the base line upwards without limit.
 - (b) The transverse extent of damage is equal to $B/5$ or 11.5 m, whichever is the lesser, measured inboard from the side of the ship perpendicularly to the centreline at the level of the summer load waterline.
 - (c) If damage of a lesser extent than specified in subparagraphs (a) and (b) results in a more severe condition, such lesser extent shall be assumed.
 - (d) Except where otherwise required by paragraph (10)(a), the flooding shall be confined to a single compartment between adjacent transverse bulkheads, provided that the inner longitudinal boundary of the compartment is not in a position within the transverse extent of assumed damage. Transverse boundary bulkheads of wing tanks which do not extend over the full breadth of the ship shall be assumed not to be damaged, provided that they extend beyond the transverse extent of assumed damage prescribed in subparagraph (b).
If in a transverse bulkhead there are steps or recesses of not more than 3 m in length, located within the transverse extent of assumed damage as defined in subparagraph (b), such transverse bulkhead may be considered intact and the adjacent compartment may be floodable singly. If, however, within the transverse extent of assumed damage there is a step or recess of more than 3 m in length in a transverse bulkhead, the two compartments adjacent to this bulkhead shall be considered as flooded. The step formed by the afterpeak bulkhead and the afterpeak tank top shall not be regarded as a step for the purpose of this regulation.
 - (e) Where a main transverse bulkhead is located within the transverse extent of assumed damage and is stepped in way of a double bottom or side tank by more than 3 m, the double bottom or side tanks adjacent to the stepped portion of the main transverse bulkhead shall be considered as flooded simultaneously. If this side tank has openings into one or

several holds, such as grain feeding holes, such hold or holds shall be considered as flooded simultaneously. Similarly, in a ship designed for the carriage of fluid cargoes, if a side tank has openings into adjacent compartments, such adjacent compartments shall be considered as empty and as being flooded simultaneously. This provision is applicable even where such openings are fitted with closing appliances, except in the case of sluice valves fitted in bulkheads between tanks and where the valves are controlled from the deck. Manhole covers with closely spaced bolts are considered equivalent to the unpierced bulkhead, except in the case of openings in topside tanks making the topside tanks common to the holds.

- (f) Where the flooding of any two adjacent fore and aft compartments is envisaged, main transverse watertight bulkheads shall be spaced at least $1/3 L^{2/3}$ or 14.5 m, whichever is the lesser, in order to be considered effective. Where transverse bulkheads are spaced at a lesser distance, one or more of these bulkheads shall be assumed as non-existent in order to achieve the minimum spacing between bulkheads.

Condition of equilibrium

- (13) The condition of equilibrium after flooding shall be regarded as satisfactory provided:
 - (a) The final waterline after flooding, taking into account sinkage, heel and trim, is below the lower edge of any opening through which progressive downflooding may take place. Such openings shall include air pipes, ventilators (even if they comply with regulation 19(4)) and openings which are closed by means of weathertight doors (even if they comply with regulation 12) or hatch covers (even if they comply with regulation 16(1) through (5)), and may exclude those openings closed by means of manhole covers and flush scuttles (which comply with regulation 18), cargo hatch covers of the type described in regulation 27(2), remotely operated sliding watertight doors, and sidescuttles of the non-opening type (which comply with regulation 23). However, in the case of doors separating a main machinery space from a steering gear compartment, watertight doors may be of a hinged, quick-acting type kept closed at sea whilst not in use, provided also that the lower sill of such doors is above the summer load waterline.
 - (b) If pipes, ducts or tunnels are situated within the assumed extent of damage penetration as defined in paragraph (12)(b), arrangements shall be made so that progressive

flooding cannot thereby extend to compartments other than those assumed to be floodable in the calculation for each case of damage.

- (c) The angle of heel due to unsymmetrical flooding does not exceed 15°. If no part of the deck is immersed, an angle of heel of up to 17° may be accepted.
- (d) The metacentric height in the flooded condition is positive.
- (e) When any part of the deck outside the compartment assumed flooded in a particular case of damage is immersed, or in any case where the margin of stability in the flooded condition may be considered doubtful, the residual stability is to be investigated. It may be regarded as sufficient if the righting lever curve has a minimum range of 20° beyond the position of equilibrium with a maximum righting lever of at least 0.1 m within this range. The area under the righting lever curve within this range shall be not less than 0.0175 m.rad. The Administration shall give consideration to the potential hazard presented by protected or unprotected openings which may become temporarily immersed within the range of residual stability.
- (f) The Administration is satisfied that the stability is sufficient during intermediate stages of flooding.

Ships without means of propulsion

- (14) A lighter, barge or other ship without independent means of propulsion shall be assigned a freeboard in accordance with the provisions of these regulations.
Barges which meet the requirements of paragraphs (2) and (3) may be assigned type "A" freeboards:
 - (a) The Administration should especially consider the stability of barges with cargo on the weather deck. Deck cargo can only be carried on barges to which the ordinary type "B" freeboard is assigned.
 - (b) However, in the case of barges which are unmanned, the requirements of regulations 25, 26(3), 26(4) and 39 shall not apply.
 - (c) Such unmanned barges which have on the freeboard deck only small access openings closed by watertight gasketed covers of steel or equivalent material may be assigned a freeboard 25% less than those calculated in accordance with these regulations.

Regulation 28

*Freeboard tables***Type ‘A’ ships**

- (1) The tabular freeboard for type “A” ships shall be determined from table 28.1:

Table 28.1
Freeboard table for type “A” ships

Length of ship (m)	Free-board (mm)	Length of ship (m)	Free-board (mm)	Length of ship (m)	Free-board (mm)
24	200	51	455	78	814
25	208	52	467	79	828
26	217	53	478	80	841
27	225	54	490	81	855
28	233	55	503	82	869
29	242	56	516	83	883
30	250	57	530	84	897
31	258	58	544	85	911
32	267	59	559	86	926
33	275	60	573	87	940
34	283	61	587	88	955
35	292	62	600	89	969
36	300	63	613	90	984
37	308	64	626	91	999
38	316	65	639	92	1014
39	325	66	653	93	1029
40	334	67	666	94	1044
41	344	68	680	95	1059
42	354	69	693	96	1074
43	364	70	706	97	1089
44	374	71	720	98	1105
45	385	72	733	99	1120
46	396	73	746	100	1135
47	408	74	760	101	1151
48	420	75	773	102	1166
50	443	77	800	104	1196
105	1212	168	2240	231	2880
106	1228	169	2254	232	2888
107	1244	170	2268	233	2895
108	1260	171	2281	234	2903
109	1276	172	2294	235	2910
110	1293	173	2307	236	2918
111	1309	174	2320	237	2925
112	1326	175	2332	238	2932

Length of ship (m)	Free-board (mm)	Length of ship (m)	Free-board (mm)	Length of ship (m)	Free-board (mm)
113	1342	176	2345	239	2939
114	1359	177	2357	240	2946
115	1376	178	2369	241	2953
116	1392	179	2381	242	2959
117	1409	180	2393	243	2966
118	1426	181	2405	244	2973
119	1442	182	2416	245	2979
120	1459	183	2428	246	2986
121	1476	184	2440	247	2993
122	1494	185	2451	248	3000
123	1511	186	2463	249	3006
124	1528	187	2474	250	3012
125	1546	188	2486	251	3018
126	1563	189	2497	252	3024
127	1580	190	2508	253	3030
128	1598	191	2519	254	3036
129	1615	192	2530	255	3042
130	1632	193	2541	256	3048
131	1650	194	2552	257	3054
132	1667	195	2562	258	3060
133	1684	196	2572	259	3066
134	1702	197	2582	260	3072
135	1719	198	2592	261	3078
136	1736	199	2602	262	3084
137	1753	200	2612	263	3089
138	1770	201	2622	264	3095
139	1787	202	2632	265	3101
140	1803	203	2641	266	3106
141	1820	204	2650	267	3112
142	1837	205	2659	268	3117
143	1853	206	2669	269	3123
144	1870	207	2678	270	3128
145	1886	208	2687	271	3133
146	1903	209	2696	272	3138
147	1919	210	2705	273	3143
148	1935	211	2714	274	3148
149	1952	212	2723	275	3153
150	1968	213	2732	276	3158
151	1984	214	2741	277	3163
152	2000	215	2749	278	3167
153	2016	216	2758	279	3172
154	2032	217	2767	280	3176
155	2048	218	2775	281	3181
156	2064	219	2784	282	3185
157	2080	220	2792	283	3189
158	2096	221	2801	284	3194
159	2111	222	2809	285	3198

Length of ship (m)	Free-board (mm)	Length of ship (m)	Free-board (mm)	Length of ship (m)	Free-board (mm)
160	2126	223	2817	286	3202
161	2141	224	2825	287	3207
162	2155	225	2833	288	3211
163	2169	226	2841	289	3215
164	2184	227	2849	290	3220
165	2198	228	2857	291	3224
166	2212	229	2865	292	3228
167	2226	230	2872	293	3233
294	3237	318	3325	342	3387
295	3241	319	3328	343	3389
296	3246	320	3331	344	3392
297	3250	321	3334	345	3394
298	3254	322	3337	346	3396
299	3258	323	3339	347	3399
300	3262	324	3342	348	3401
301	3266	325	3345	349	3403
302	3270	326	3347	350	3406
303	3274	327	3350	351	3408
304	3278	328	3353	352	3410
305	3281	329	3355	353	3412
306	3285	330	3358	354	3414
307	3288	331	3361	355	3416
308	3292	332	3363	356	3418
309	3295	333	3366	357	3420
310	3298	334	3368	358	3422
311	3302	335	3371	359	3423
312	3305	336	3373	360	3425
313	3308	337	3375	361	3427
314	3312	338	3378	362	3428
315	3315	339	3380	363	3430
316	3318	340	3382	364	3432
317	3322	341	3385	365	3433

Freeboards at intermediate lengths of ship shall be obtained by linear interpolation.

Ships above 365 m in length shall be dealt with by the Administration.

Type “B” ships

- (2) The tabular freeboard for type “B” ships shall be determined from table 28.2:

Table 28.2
Freeboard table for type “B” ships

Length of ship (m)	Free- board (mm)	Length of ship (m)	Free- board (mm)	Length of ship (m)	Free- board (mm)
24	200	70	721	116	1609
25	208	71	738	117	1630
26	217	72	754	118	1651
27	225	73	769	119	1671
28	233	74	784	120	1690
29	242	75	800	121	1709
30	250	76	816	122	1729
31	258	77	833	123	1750
32	267	78	850	124	1771
33	275	79	868	125	1793
34	283	8d	887	126	1815
35	292	81	905	127	1837
36	300	82	923	128	1859
37	308	83	942	129	1880
38	316	84	960	130	1901
39	325	85	978	131	1921
40	334	86	996	132	1940
41	344	87	1015	133	1959
42	354	88	1034	134	1979
43	364	89	1054	135	2000
44	374	90	1075	136	2021
45	385	91	1096	137	2043
46	396	92	1116	138	2065
47	408	93	1135	139	2087
48	420	94	1154	140	2109
49	432	95	1172	141	2130
50	443	96	1190	142	2151
51	455	97	1209	143	2171
52	467	98	1229	144	2190
53	478	99	1250	145	2209
54	490	100	1271	146	2229
55	503	101	1293	147	2250
56	516	102	1315	148	2271
57	530	103	1337	149	2293
58	544	104	1359	150	2315
59	559	105	1380	151	2334
60	573	106	1401	152	2354
61	587	107	1421	153	2375
62	601	108	1440	154	2396

Length of ship (m)	Free- board (mm)	Length of ship (m)	Free- board (mm)	Length of ship (m)	Free- board (mm)
63	615	109	1459	155	2418
64	629	110	1479	156	2440
65	644	111	1500	157	2460
66	659	112	1521	158	2480
67	674	113	1543	159	2500
68	689	114	1565	160	2520
69	705	115	1587	161	2540
162	2560	225	3660	288	4490
163	2580	226	3675	289	4502
164	2600	227	3690	290	4513
165	2620	228	3705	291	4525
166	2640	229	3720	292	4537
167	2660	230	3735	293	4548
168	2680	231	3750	294	4560
169	2698	232	3765	295	4572
170	2716	233	3780	296	4583
171	2735	234	3795	297	4595
172	2754	235	3808	298	4607
173	2774	236	3821	299	4618
174	2795	237	3835	300	4630
175	2815	238	3849	301	4642
176	2835	239	3864	302	4654
177	2855	240	3880	303	4665
178	2875	241	3893	304	4676
179	2895	242	3906	305	4686
180	2915	243	3920	306	4695
181	2933	244	3934	307	4704
182	2952	245	3949	308	4714
183	2970	246	3965	309	4725
184	2988	247	3978	310	4736
185	3007	248	3992	311	4748
186	3025	249	4005	312	4757
187	3044	250	4018	313	4768
188	3062	251	4032	314	4779
189	3080	252	4045	315	4790
190	3098	253	4058	316	4801
191	3116	254	4072	317	4812
192	3134	255	4085	318	4823
193	3151	256	4098	319	4834
194	3167	257	4112	320	4844
195	3185	258	4125	321	4855

Length of ship (m)	Free- board (mm)	Length of ship (m)	Free- board (mm)	Length of ship (m)	Free- board (mm)
196	3202	259	4139	322	4866
197	3219	260	4152	323	4878
198	3235	261	4165	324	4890
199	3249	262	4177	325	4899
200	3264	263	4189	326	4909
201	3280	264	4201	327	4920
202	3296	265	4214	328	4931
203	3313	266	4227	329	4943
204	3330	267	4240	330	4955
205	3347	268	4252	331	4965
206	3363	269	4264	332	4975
207	3380	270	4276	333	4985
208	3397	271	4289	334	4995
209	3413	272	4302	335	5005
210	3430	273	4315	336	5015
211	3445	274	4327	337	5025
212	3460	275	4339	338	5035
213	3475	276	4350	339	5045
214	3490	277	4362	340	5055
215	3505	278	4373	341	5065
216	3520	279	4385	342	5075
217	3537	280	4397	343	5086
218	3554	281	4408	344	5097
219	3570	282	4420	345	5108
220	3586	283	4432	346	5119
221	3601	284	4443	347	5130
222	3615	285	4455	348	5140
223	3630	286	4467	349	5150
224	3645	287	4478	350	5160
351	5170	356	5220	361	5268
352	5180	357	5230	362	5276
353	5190	358	5240	363	5285
354	5200	359	5250	364	5294
355	5210	360	5260	365	5303

Freeboards at intermediate lengths of ship shall be obtained by linear interpolation.

Ships above 365 m in length shall be dealt with by the Administration.

Regulation 29

Correction to the freeboard for ships under 100 m in length

The tabular freeboard for a type “B” ship of between 24 m and 100 m in length having enclosed superstructures with an effective length of up to 35% of the length of the ship shall be increased by:

$$7.5(100 - L)\left(0.35 - \frac{E_1}{L}\right) \text{ (mm)}$$

where L is the length of the ship in m; and

E₁ is the effective length E of superstructure in m as defined in regulation 35, but excluding the length of trunks.

Regulation 30

Correction for block coefficient

Where the block coefficient (C_b) exceeds 0.68, the tabular freeboard specified in regulation 28 as modified, if applicable, by regulations 27(8), 27(10) and 29 shall be multiplied by the factor:

$$\frac{C_b + 0.68}{1.36}$$

The block coefficient is not to be taken greater than 1.0.

Regulation 31

Correction for depth

- (1) Where D exceeds $\frac{L}{15}$ the freeboard shall be increased by $(D - \frac{L}{15})R$ (mm), where R is $\frac{L}{0.48}$ at lengths less than 120 m and 250 at 120 m length and above.
- (2) Where D is less than $\frac{L}{15}$ no reduction shall be made, except in a ship with an enclosed superstructure covering at least 0.6L amidships, with a complete trunk, or combination of detached enclosed superstructures and trunks which extend all fore and aft, where the freeboard shall be reduced at the rate prescribed in paragraph (1).
- (3) Where the height of the superstructure or trunk is less than the corresponding standard height, the calculated reduction shall be corrected in the ratio of the height of the actual superstructure or trunk to the applicable standard height, as defined in regulation 33.

Regulation 32

Correction for position of deck line

Where the actual depth to the upper edge of the deck line is greater or less than D , the difference between the depths shall be added to or deducted from the freeboard.

Regulation 32-1

Correction for recess in freeboard deck

- (1) Where a recess is arranged in the freeboard deck, and it does not extend to the sides of the ship, the freeboard calculated without regard to the recess shall be corrected for the consequent loss of buoyancy. The correction shall be equal to the value obtained by dividing the volume of the recess by the waterplane area of the ship at 85% of the least moulded depth (see figure 32-1.1).
- (2) The correction shall be an addition to the freeboard obtained after all other corrections have been applied, except bow height correction.
- (3) Where the freeboard, corrected for lost buoyancy as above, is greater than the minimum geometric freeboard determined on the basis of a moulded depth measured to the bottom of the recess, the latter value may be used.

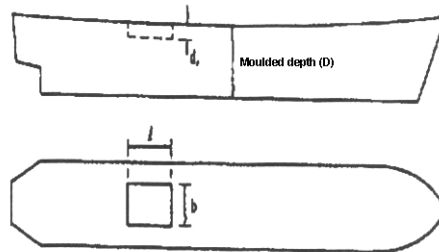

Figure 32-1.1

Correction is the addition to freeboard equal to: $\frac{l \times b \times d_r}{WP \text{ Area at } 0.85 D}$

Regulation 33

Standard height of superstructure

The standard height of a superstructure shall be as given in table 33.1:

L (m)	Standard height (in m)	
	Raised quarterdeck	All other superstructures
30 or less	0.9	1.8
75	1.2	1.8
125 or more	1.8	2.3

Table 33.1

The standard heights at intermediate lengths of the ship shall be obtained by linear interpolation.

Regulation 34

Length of superstructure

- (1) Except as provided in paragraph (2), the length of a superstructure (S) shall be the mean length of the parts of the superstructure which lie within the length (L).
Where a superstructure bulkhead is recessed, the effective length of the superstructure shall be reduced by an amount equal to the area of the recess in plan view divided by the breadth of the superstructure at the midlength of the recess. Where the recess is unsymmetrical about the centreline, the largest portion of the recess shall be considered as applying to both sides of the ship. A recess need not be decked over.
- (2) Where the end bulkhead of an enclosed superstructure extends in a fair convex curve beyond its intersection with the superstructure sides, the length of the superstructure may be increased on the basis of an equivalent plane bulkhead. This increase shall be two-thirds of the fore and aft extent of the curvature. The maximum curvature which may be taken into account in determining this increase is one-half the breadth of the superstructure at the point of intersection of the curved end of the superstructure with its side.
Where there is an extension to a superstructure, which extension has a breadth on each side of the centre line at least 30% of the breadth of the ship, the effective length of the super-

structure may be increased by considering an equivalent superstructure bulkhead in the form of a parabola. This parabola shall extend from the extension at the centreline and pass through the junction of the actual superstructure bulkhead with the sides of the extension and extend to the sides of the ship. This parabola shall be completely contained within the boundary of the superstructure and its extensions.

If the superstructure is set-in from the side, up to the limit allowed under regulation 3(10), the equivalent bulkhead should be calculated on the basis of the actual breadth of the superstructure (and not the breadth of the ship).

- (3) Superstructures which have sloped end bulkheads shall be dealt with in the following manner:
- When the height of superstructure, clear of the slope, is equal to or smaller than the standard height, the length S is to be obtained as shown in figure 34.1.
 - When the height is greater than the standard, the length S is to be obtained as shown in figure 34.2.
 - The foregoing will apply only when the slope, related to the base line, is 15° or greater. Where the slope is less than 15° , the configuration shall be treated as sheer.

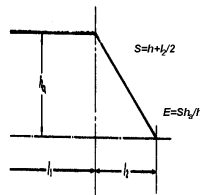

Figure 34.1 Height of superstructure equal to or smaller than the standard height h

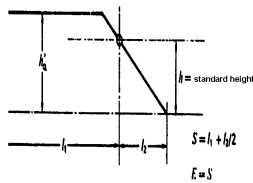

Figure 34.2 Height of superstructure greater than the standard height

Regulation 35

Effective length of superstructure

- (1) Except as provided for in paragraph (2), the effective length (E) of an enclosed superstructure of standard height shall be its length.
- (2) In all cases where an enclosed superstructure of standard height is set-in from the sides of the ship as permitted in regulation 3(10), the effective length shall be the length modified by the ratio of b/B_s , where:
b is the breadth of the superstructure at the middle of its length; and
 B_s is the breadth of the ship at the middle of the length of the superstructure.
Where a superstructure is set-in for a part of its length, this modification shall be applied only to the set-in part.
- (3) Where the height of an enclosed superstructure is less than the standard height, the effective length shall be its length reduced in the ratio of the actual height to the standard height. Where the height exceeds the standard, no increase shall be made to the effective length of the superstructure (see figures 34.1 and 34.2).
Where the height, clear of the slope, of a superstructure which has sloped end bulkheads is less than the standard height, its effective length E shall be its length S as obtained from figure 34.1, reduced in the ratio of the actual height to the standard height.
Where a poop or forecastle of less than standard height is fitted on a ship with excessive sheer but without any superstructure within 0.2L amidships, credit may be given to the height of the poop or forecastle by increasing the actual height by the difference between the actual and the standard sheer profiles. The deduction for excess sheer in accordance with regulation 38(16) is not to be granted.
- (4) The effective length of a raised quarter deck, if fitted with an intact front bulkhead, shall be its length up to a maximum of 0.6L. Where the bulkhead is not intact, the raised quarter deck shall be treated as a poop of less than standard height.
The maximum effective length of 0.6L of a raised quarterdeck is to be measured from the after perpendicular, even where a poop is fitted in conjunction with the raised quarterdeck.
- (5) Superstructures which are not enclosed shall have no effective length.

Regulation 36

Trunks

- (1) A trunk or similar structure which does not extend to the sides of the ship shall be regarded as efficient on the following conditions:
 - (a) the trunk is at least as strong as a superstructure;
 - (b) the hatchways are in the trunk deck, the hatchway coamings and covers comply with the requirements of regulations 13 to 16 inclusive and the width of the trunk deck stringer provides a satisfactory gangway and sufficient lateral stiffness. However, small access openings with watertight covers may be permitted in the freeboard deck;
 - (c) a permanent working platform fore and aft fitted with guard rails is provided by the trunk deck, or by detached trunks connected to superstructures by efficient permanent gangways;
 - (d) ventilators are protected by the trunk, by watertight covers or by other equivalent means;
 - (e) open rails are fitted on the weather parts of the freeboard deck in way of the trunk for at least half their length or, alternatively, freeing port area in the lower part of the bulwarks, subject to regulation 24(2), of 33% of the total area of the bulwarks is provided;
 - (f) the machinery casings are protected by the trunk, by a superstructure of at least standard height, or by a deck-house of the same height and of equivalent strength;
 - (g) the breadth of the trunk is at least 60% of the breadth of the ship; and
 - (h) where there is no superstructure, the length of the trunk is at least 0.6L.
- (2) The full length of an efficient trunk reduced in the ratio of its mean breadth to B shall be its effective length.
- (3) The standard height of a trunk is the standard height of a superstructure other than a raised quarter deck.
- (4) Where the height of a trunk is less than the standard height, its effective length shall be reduced in the ratio of the actual to the standard height. Where the height of hatchway coamings on the trunk deck is less than that required under regulation 14-1, a reduction from the actual height of trunk shall be made which corresponds to the difference between the actual and the required height of coaming.
- (5) Where the trunk height is less than standard and the trunk hatch coamings are also of less than standard height, or omitted entirely, the reduction from the actual height of trunk on

account of insufficient hatch coaming height shall be taken as the difference between 600 mm and the actual height of coaming, or 600 mm if no hatch coamings are fitted. Reduction in the actual height of trunk shall not be required in cases where only small hatches with less than standard height are fitted in the trunk deck for which dispensation from the requirement of standard coaming height may be given.

- (6) Continuous hatchways may be treated as a trunk in the freeboard computation, provided the provisions of this paragraph are complied with in all respects.
The trunk deck stringer referred to in paragraph (1)(b) may be fitted outboard of the trunk side bulkhead in association with the following:
- (a) the stringer so formed is to provide a clear walkway of at least 450 mm in width on each side of the ship;
 - (b) the stringer is to be of solid plate, efficiently supported and stiffened;
 - (c) the stringer is to be as high above the freeboard deck as practicable. In the freeboard calculation, the trunk height is to be reduced by at least 600 mm or by the actual difference between the top of the trunk and the stringer, whichever is greater;
 - (d) hatch cover securing appliances are to be accessible from the stringer or walkway; and
 - (e) the breadth of the trunk is to be measured between the trunk side bulkheads.
- (7) Where the trunk adjoining the superstructures such as poop, bridge or forecastle is included in the calculation of freeboard, openings shall not be arranged in that part of the bulkhead which is common for the trunk and superstructure. A relaxation may be made for small openings such as for piping, cable or manholes with covers attached by means of bolts.
- (8) The sides of a trunk included in the calculation of freeboard shall be intact. Side scuttles of the non-opening type and bolted manhole covers may be allowed.

Regulation 37

Deduction for superstructures and trunks

- (1) Where the effective length of superstructures and trunks is 1L, the deduction from the freeboard shall be 350 mm at 24 m length of ship, 860 mm at 85 m length and 1,070 mm at 122 m length and above. Deductions at intermediate lengths shall be obtained by linear interpolation.
- (2) Where the total effective length of superstructures and trunks

is less than 1L, the deduction shall be a percentage obtained from table 37.1:

Tabel 37.1
Percentage of deduction for type “A” and “B” ships

	Total effective length of superstructures and trunks										
Percentage of deduction for all types of superstructure	0	0.1 L	0.2 L	0.3 L	0.4 L	0.5 L	0.6 L	0.7 L	0.8 L	0.9 L	1 L
	0	7	14	21	31	41	52	63	75.3	87.7	100

Percentages at intermediate lengths of superstructures and trunks shall be obtained by linear interpolation.

- (3) For ships of type “B” where the effective length of a forecastle is less than 0.07L no deduction is allowed.

Regulation 38

Sheer

General

- (1) The sheer shall be measured from the deck at side to a line of reference drawn parallel to the keel through the sheer line amidships.
- (2) In ships designed with a rake of keel, the sheer shall be measured in relation to a reference line drawn parallel to the design load waterline.
- (3) In flush deck ships and in ships with detached superstructures the sheer shall be measured at the freeboard deck.
- (4) In ships with topsides of unusual form in which there is a step or break in the topsides, the sheer shall be considered in relation to the equivalent depth amidships.
- (5) In ships with a superstructure of standard height which extends over the whole length of the freeboard deck, the sheer shall be measured at the superstructure deck. Where the height exceeds the standard, the least difference (Z) between the actual and standard heights shall be added to each end ordinate. Similarly, the intermediate ordinates at distances of 1/6L and 1/3L from each perpendicular shall be increased by 0.444Z and 0.111Z, respectively. Where there is an enclosed poop or forecastle

superimposed on the superstructure, sheer credit shall be allowed for such a poop or forecastle, according to the method of paragraph (12) as shown in figure 38.1.

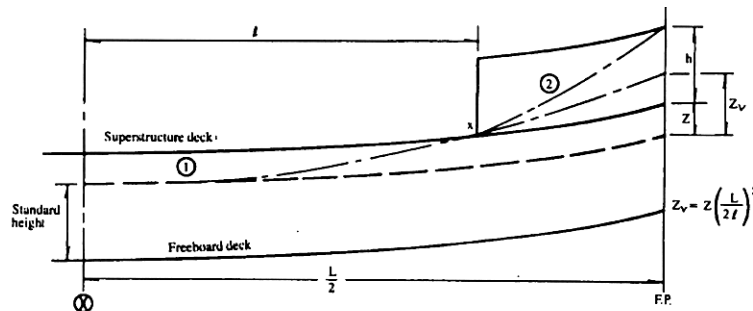

Figure 38.1

- (6) Where the deck of an enclosed superstructure has at least the same sheer as the exposed freeboard deck, the sheer of the enclosed portion of the freeboard deck shall not be taken into account.
- (7) Where an enclosed poop or forecastle is of standard height with greater sheer than that of the freeboard deck, or is of more than standard height, an addition to the sheer of the freeboard deck shall be made as provided in paragraph (12).

Where a poop or forecastle consists of two layers, the method shown in figure 38.2 shall be used.

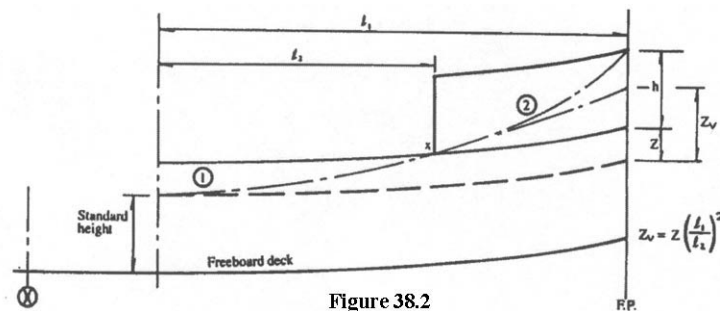

Figure 38.2

In figures 38.1 and 38.2, the following definitions apply:

Z is as defined in paragraph (5); and

Z_v is the end ordinate of a virtual standard parabolic curve taken through the point "X". If Z_v is greater than $(Z + h)$, the end

ordinate shall be $(Z + h)$, in which case point "X" shall be disregarded and curve (2) not taken into account.
 When the length of the first tier superstructure is greater than 0.5L, the virtual standard parabolic curve shall commence at amidships as indicated in figure 38.1.

Standard sheer profile

(8) The ordinates of the standard sheer profile are given in table 38.1:

Table 38.1
Standard sheer profile
 (where L is in m)

	Station	Ordinate (in mm)	Factor
After half	After perpendicular	$25 \left(\frac{L}{3} + 10\right)$	1
	$\frac{1}{6}$ L from A.P.	$11.1 \left(\frac{L}{3} + 10\right)$	3
	$\frac{1}{3}$ L from A.P.	$2.8 \left(\frac{L}{3} + 10\right) L$	3
	Amidships	0	1
Forward half	Amidships	0	1
	$\frac{1}{3}$ L from F.P.	$5.6 \left(\frac{L}{3} + 10\right)$	3
	$\frac{1}{6}$ L from F.P.	$22.2 \left(\frac{L}{3} + 10\right)$	3
	Forward perpendicular	$50 \left(\frac{L}{3} + 10\right)$	1

Measurement of variation from standard sheer profile

- (9) Where the sheer profile differs from the standard, the four ordinates of each profile in the forward or after half shall be multiplied by the appropriate factors given in the above table of ordinates. The difference between the sums of the respective products and those of the standard divided by 8 measures the deficiency or excess of sheer in the forward or after half. The arithmetical mean of the excess or deficiency in the forward and after halves measures the excess or deficiency of sheer.
- (10) Where the after half of the sheer profile is greater than the standard and the forward half is less than the standard, no

credit shall be allowed for the part in excess and deficiency only shall be measured.

- (11) Where the forward half of the sheer profile exceeds the standard, and the after portion of the sheer profile is not less than 75% of the standard, credit shall be allowed for the part in excess. Where the after part is less than 50% of the standard no credit shall be given for the excess sheer forward. Where the after sheer is between 50% and 75% of the standard, intermediate allowances may be granted for excess sheer forward.

- (12) Where sheer credit is given for a poop or forecastle the following formula shall be used: $s = \frac{yL'}{3L}$

where: s is the sheer credit, to be deducted from the deficiency, or added to the excess of sheer;

y is the difference between actual and standard height of superstructure at the after or forward perpendicular;

L' is the mean enclosed length of poop or forecastle up to a maximum length of 0.5 L ; and

L is the length of the ship as defined in regulation 3(1).

The above formula provides a curve in the form of a parabola tangent to the actual sheer curve at the freeboard deck and intersecting the end ordinate at a point below the superstructure deck a distance equal to the standard height of a superstructure. The superstructure deck shall not be less than standard height above this curve at any point. This curve shall be used in determining the sheer profile for forward and after halves of the ship.

- (13) (a) Any excess in the height of a superstructure which does not extend to the after perpendicular cannot be regarded as contributing to the sheer allowance.
- (b) Where the height of a superstructure is less than standard, the superstructure deck shall not be less than the minimum height of the superstructure above the virtual sheer curve at any point. For this purpose y shall be taken as the difference between the actual and minimum height of the superstructure at the after/forward perpendicular.
- (c) For a raised quarterdeck credit may be given only when the height of this quarterdeck is greater than the standard height of "other superstructures" as defined in regulation 33, and only for the amount by which the actual height of the raised quarterdeck exceeds that standard height.
- (d) When a poop or a forecastle has sloping end bulkheads, the sheer credit may be allowed on account of excess height. The formula given in paragraph (12) shall be

used, the values for y and L' being as shown in figure 38.3.

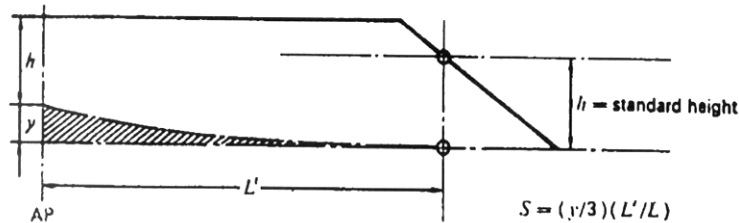

Figure 38.3 Shear credit S for excess height

Correction for variations from standard shear profile

- (14) The correction for shear shall be the deficiency or excess of shear (see paragraphs (9) to (11) inclusive), multiplied by

$$0.75 \frac{S_1}{2L}$$

where S_1 is the total length S of enclosed superstructures as defined in regulation 34 without trunks.

Addition for deficiency in shear

- (15) Where the shear is less than the standard, the correction for deficiency in shear (see paragraph (14)) shall be added to the freeboard.

Deduction for excess shear

- (16) In ships where an enclosed superstructure covers 0.1L before and 0.1L abaft amidships, the correction for excess of shear as calculated under the provisions of paragraph (14) shall be deducted from the freeboard; in ships where no enclosed superstructure covers amidships, no deduction shall be made from the freeboard; where an enclosed superstructure covers less than 0.1L before and 0.1L abaft amidships, the deduction shall be obtained by linear interpolation. The maximum deduction for excess shear shall be at the rate of 125 mm per 100 m of length. In applying this paragraph, the height of the superstructure shall be related to its standard height. Where the height of the superstructure or raised quarterdeck is less than standard, the

reduction shall be in the ratio of the actual to the standard height thereof.

Regulation 39

Minimum bow height and reserve buoyancy

- (1) The bow height (F_b), defined as the vertical distance at the forward perpendicular between the waterline corresponding to the assigned summer freeboard and the designed trim and the top of the exposed deck at side, shall be not less than:

$$F_b = (6075(L/100) - 1875(L/100)^2 + 200(L/100)^3) \times (2.08 + 0.609C_b - 1.603C_{wf} - 0.0129(L/d_1))$$

where:

- F_b is the calculated minimum bow height, in mm;
 L is the length, as defined in regulation 3, in m;
 B is the moulded breadth, as defined in regulation 3, in m;
 d_1 is the draught at 85% of the depth D , in m;
 C_b is the block coefficient, as defined in regulation 3;
 C_{wf} is the waterplane area coefficient forward of $L/2$: $C_{wf} = A_{wf} / \{(L/2) \times B\}$;
 A_{wf} is the waterplane area forward of $L/2$ at draught d_1 , in m^2 .

For ships to which timber freeboards are assigned, the summer freeboard (and not the timber summer freeboard) is to be assumed when applying paragraph (1).

- (2) Where the bow height required in paragraph (1) is obtained by sheer, the sheer shall extend for at least 15% of the length of the ship measured from the forward perpendicular. Where it is obtained by fitting a superstructure, such superstructure shall extend from the stem to a point at least $0.07L$ abaft the forward perpendicular, and shall be enclosed as defined in regulation 3(10).
- (3) Ships which, to suit exceptional operational requirements, cannot meet the requirements of paragraphs (1) and (2) of this regulation may be given special consideration by the Administration.
- (4) (a) The sheer of the forecastle deck may be taken into account, even if the length of the forecastle is less than $0.15L$, but greater than $0.07L$, provided that the forecastle height is not less than one half of standard height of superstructure as defined in regulation 33 between $0.07L$ and the forward perpendicular.
- (b) Where the forecastle height is less than one half of the standard height of superstructure, as defined in regulation 33, the credited bow height may be determined as follows:
- (i) Where the freeboard deck has sheer extending from

abaft 0.15L, by a parabolic curve having its origin at 0.15L abaft the forward perpendicular at a height equal to the midship depth of the ship, extended through the point of intersection of forecastle bulkhead and deck, and up to a point at the forward perpendicular not higher than the level of the forecastle deck (as illustrated in figure 39.1).

However, if the value of the height denoted h_t in figure 39.1 is smaller than the value of the height denoted h_b , then h_t may be replaced by h_b in the available bow height.

- (ii) Where the freeboard deck has sheer extending for less than 0.15L or has no sheer, by a line from the forecastle deck at side at 0.07L extended parallel to the base line to the forward perpendicular (as illustrated in figure 39.2).

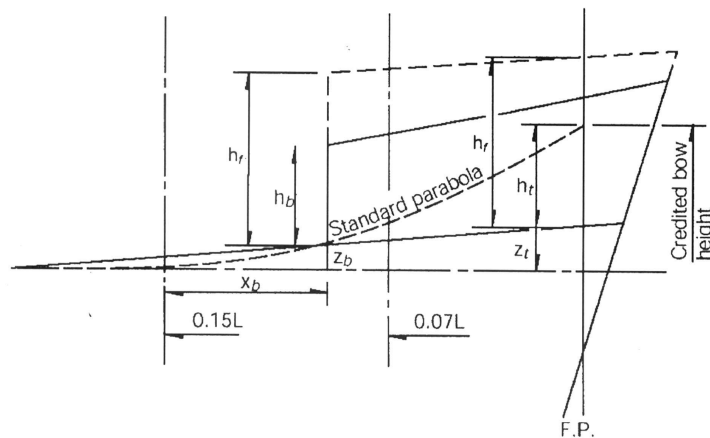

Figure 39.1

$$h_t = z_b \left(\frac{0.15L}{x_b} \right)^2 - z_t$$

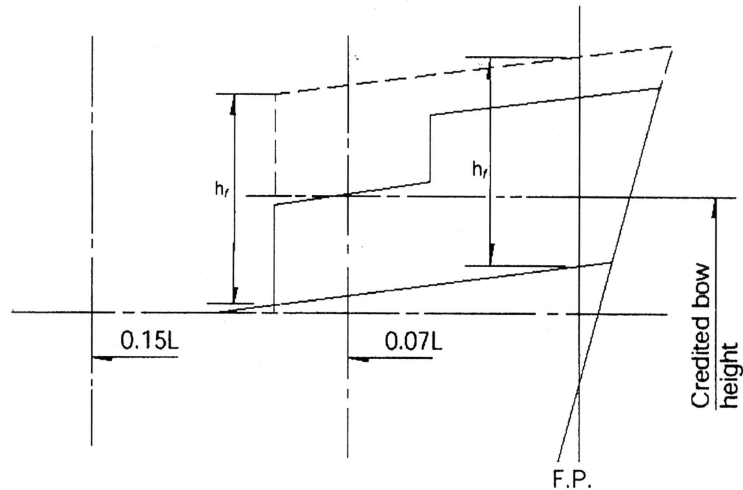

Figure 39.2

h_f = Half standard height of superstructure as defined in regulation 33.

- (5) All ships assigned a type "B" freeboard, other than oil tankers*, chemical tankers* and gas carriers*, shall have additional reserve buoyancy in the fore end. Within the range of $0.15L$ abaft of the forward perpendicular, the sum of the projected area between the summer load waterline and the deck at side (A1 and A2 in figure 39.3) and the projected area of an enclosed superstructure, if fitted, (A3) shall not be less than: $(0.15F_{\min} + 4(L/3 + 10))L/1000 \text{ m}^2$, where:

F_{\min} is calculated by: $F_{\min} = (F_0 \times f_1) + f_2$;

F_0 is the tabular freeboard, in mm, taken from table 28.2, corrected for regulation 27(9) or 27(10), as applicable;

f_1 is the correction for block coefficient given in regulation 30; and

f_2 is the correction for depth, in mm, given in regulation 31.

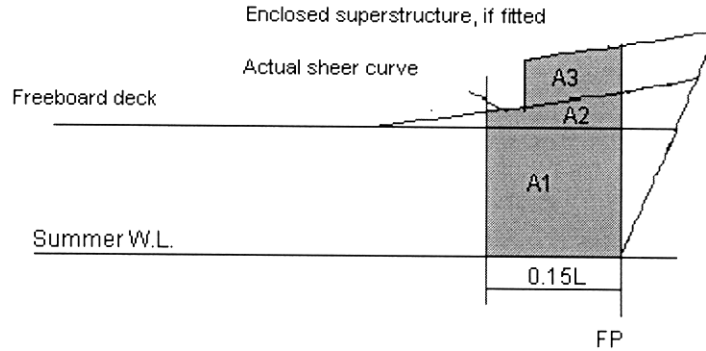

Figure 39.3

Regulation 40

Minimum freeboards

Summer freeboard

- (1) The minimum freeboard in summer shall be the freeboard derived from the tables in regulation 28, as modified by the corrections in regulations 27, as applicable, 29, 30, 31, 32, 37, 38 and, if applicable, 39.
- (2) The freeboard in salt water, as calculated in accordance with paragraph (1), but without the correction for deck line, as provided by regulation 32, shall not be less than 50 mm. For ships having in position 1 hatchways with covers which do not comply with the requirements of regulation 16(1) through (5) or regulation 26, the freeboard shall be not less than 150 mm.

Tropical freeboard

- (3) The minimum freeboard in the Tropical Zone shall be the freeboard obtained by a deduction from the summer freeboard of one forty-eighth of the summer draught measured from the top of the keel to the centre of the ring of the load line mark.
- (4) The freeboard in salt water, as calculated in accordance with paragraph (3), but without the correction for deck line, as provided by regulation 32, shall not be less than 50 mm. For ships having in position 1 hatchways with covers which do not comply with the requirements of regulation 16(1) through (5)

or regulation 26, the freeboard shall be not less than 150 mm.

Winter freeboard

- (5) The minimum freeboard in winter shall be the freeboard obtained by an addition to the summer freeboard of one forty-eighth of summer draught, measured from the top of the keel to the centre of the ring of the load line mark.

Winter North Atlantic freeboard

- (6) The minimum freeboard for ships of not more than 100 m in length which enter any part of the North Atlantic defined in regulation 52 (Annex II) during the winter seasonal period shall be the winter freeboard plus 50 mm. For other ships, the winter North Atlantic freeboard shall be the winter freeboard.

Fresh water freeboard

- (7) The minimum freeboard in fresh water of unit density shall be obtained by deducting from the minimum freeboard in salt water:

$$\frac{\Delta}{40T} \text{ (cm)}$$

where: Δ is the displacement in salt water in tonnes at the summer load waterline; and

T is the tonnes per centimetre immersion in salt water at the summer load waterline.

- (8) Where the displacement at the summer load waterline cannot be certified, the deduction shall be one forty-eight of summer draught, measured from the top of the keel to the centre of the ring of the load line mark.

CHAPTER IV

SPECIAL REQUIREMENTS FOR SHIPS ASSIGNED TIMBER FREEBOARD

Regulation 41

Application of this chapter

Regulations 42 to 45 inclusive apply only to ships to which timber load lines are assigned.

Regulation 42

Definitions

- (1) *Timber deck cargo.* The term “timber deck cargo” means a cargo of timber carried on an uncovered part of a freeboard deck. The term does not include wood pulp or similar cargo*.
- (2) *Timber load line.* A timber deck cargo may be regarded as giving a ship a certain additional buoyancy and a greater degree of protection against the sea. For that reason, ships carrying a timber deck cargo may be granted a reduction of freeboard calculated according to the provisions of regulation 45 and marked on the ship’s side in accordance with the provisions of regulations 6(3) and (4).

However, in order that such special freeboard may be granted and used, the timber deck cargo shall comply with certain conditions which are laid down in regulation 44, and the ship itself shall also comply with certain conditions relating to its construction which are set out in regulation 43.

Regulation 43

*Construction of the ship***Superstructure**

- (1) Ships shall have a forecastle of at least standard height and a length of at least 0.07L. In addition, if the ship is less than 100 m in length, a poop of at least standard height, or a raised quarterdeck with a deckhouse of at least the same total height shall be fitted aft.

Double bottom tanks

- (2) Double bottom tanks, where fitted within the midship half length of the ship, shall have adequate watertight longitudinal subdivision.

Bulwarks

- (3) The ship shall be fitted either with permanent bulwarks at least 1 m in height, specially stiffened on the upper edge and supported by strong bulwark stays attached to the deck and provid-

* Reference is made to the Code of Safe Practice for Ships Carrying Timber Deck Cargoes, adopted by the Organization by resolution A.715(17), as amended.

ed with necessary freeing ports, or with efficient rails of the same height and of specially strong construction.

Regulation 44

Stowage

General

- (1) Openings in the deck exposed to weather over which cargo is stowed shall be securely closed and battened down.
The ventilators and air pipes shall be efficiently protected.
- (2) Timber deck cargoes shall extend over at least the entire available length which is the total length of the well or wells between superstructures.
Where there is no limiting superstructure at the after end, the timber shall extend at least to the after end of the aftermost hatchway.
The timber deck cargo shall extend athwartships as close as possible to the ship's side, due allowance being made for obstructions such as guard rails, bulwark stays, uprights, pilot access, etc., provided that any gap thus created at the side of the ship shall not exceed a mean of 4% of the breadth. The timber shall be stowed as solidly as possible to at least the standard height of the superstructure other than any raised quarterdeck.
- (3) On a ship within a seasonal winter zone in winter, the height of the deck cargo above the deck exposed to weather shall not exceed one third of the extreme breadth of the ship.
- (4) The timber deck cargo shall be compactly stowed, lashed and secured. It shall not interfere in any way with the navigation and necessary work of the ship.

Uprights

- (5) Uprights, when required by the nature of the timber, shall be of adequate strength considering the breadth of the ship; the strength of the uprights shall not exceed the strength of the bulwark and the spacing shall be suitable for the length and character of timber carried, but shall not exceed 3 m. Strong angles or metal sockets or equally efficient means shall be provided for securing the uprights.

Lashings

- (6) Timber deck cargo shall be effectively secured throughout its length by a lashing system acceptable to the Administration for

the character of the timber carried*.

Stability

- (7) Provision shall be made for a safe margin of stability at all stages of the voyage, regard being given to additions of weight, such as those arising from absorption of water or icing, if applicable, and to losses of weight such as those arising from consumption of fuel and stores.

Protection of crew, access to machinery spaces, etc.

- (8) In addition to the requirements of regulation 25(5), guard-rails or lifelines not more than 350 mm apart vertically shall be provided on each side of the cargo deck to a height of at least 1 m above the cargo.
In addition a lifeline, preferably wire rope set up taut with a stretching screw, shall be provided as near as practicable to the centreline of the ship. The stanchion supports to all guard-rails and lifelines shall be so spaced as to prevent undue sagging. Where the cargo is uneven, a safe walking surface of not less than 600 mm in width shall be fitted over the cargo and effectively secured beneath or adjacent to the lifeline.
- (9) Where the requirements prescribed in paragraph (8) are impracticable, alternative arrangements satisfactory to the Administration shall be used.

Steering arrangements

- (10) Steering arrangements shall be effectively protected from damage by cargo and, as far as practicable, shall be accessible. Efficient provision shall be made for steering in the event of a breakdown in the main steering arrangements.

Regulation 45

Computation for freeboard

- (1) The minimum summer freeboards shall be computed in accordance with regulations 27(5), 27(6), 27(14), 28, 29, 30, 31, 32, 37 and 38, except that regulation 37 is modified by substituting the following percentages for those given in regulation 37:

* Reference is made to the Code of Safe Practice for Ships Carrying Timber Deck Cargoes, adopted by the Organization by resolution A.715(17), as amended.

	Total effective length of superstructure										
	0	0.1L	0.2L	0.3L	0.4L	0.5L	0.6L	0.7L	0.8L	0.9L	1.0L
Percentage of deduction for all types of superstructure	20	31	42	53	64	70	76	82	88	94	100

Percentages at intermediate lengths of superstructure shall be obtained by linear interpolation.

Table 45.1

- (2) The Winter Timber Freeboard shall be obtained by adding to the Summer Timber Freeboard one thirty-sixth of the moulded summer timber draught.
- (3) The Winter North Atlantic Timber Freeboard shall be the same as the Winter North Atlantic Freeboard prescribed in regulation 40(6).
- (4) The Tropical Timber Freeboard shall be obtained by deducting from the Summer Timber Freeboard one forty-eighth of the moulded summer timber draught.
- (5) The Fresh Water Timber Freeboard shall be computed in accordance with regulation 40(7), based on the summer timber load waterline or with regulation 40(8), based on the summer timber draught measured from the top of the keel to the summer timber load line.
- (6) Timber freeboards may be assigned to ships with reduced type "B" freeboards, provided the timber freeboards are calculated on the basis of the ordinary type "B" freeboard.
- (7) The Timber Winter mark and/or the Timber Winter North Atlantic mark shall be placed at the same level as the reduced type "B" Winter mark when the computed Timber Winter mark and/or the computed Timber Winter North Atlantic mark fall below the reduced type "B" Winter mark."

ANNEX II

ZONES, AREAS AND SEASONAL PERIODS

Regulation 49

Seasonal tropical areas

2. The existing text of paragraph 7(b) is replaced by the following:

“(b) An area bounded:

on the north and east by the southern boundary of the Tropical Zone;

on the south by the parallel of latitude of 24°S from the east coast of Australia to longitude 154°E, thence by the meridian of longitude 154°E to the Tropic of Capricorn and thence by the Tropic of Capricorn to longitude 150°W, thence by the meridian of longitude 150°W to latitude 20°S and thence by the parallel of latitude 20°S to the point where it intersects the southern boundary of the Tropical Zone; and

on the west by the boundaries of the area within the Great Barrier Reef included in the Tropical Zone and by the east coast of Australia.

Seasonal periods:

TROPICAL: 1 April to 30 November

SUMMER: 1 December to 31 March.”

C. VERTALING

Zie *Trb.* 1990, 56.

D. PARLEMENT

Zie *Trb.* 2004, 56.

Resolutie MSC.143(77) van 5 juni 2003

De wijzigingen behoeften ingevolge artikel 7, onderdeel f, van de Rijkswet goedkeuring en bekendmaking verdragen niet de goedkeuring van de Staten-Generaal.

E. PARTIJGEGEVENS

Zie *Trb.* 1989, 134 en rubriek F van *Trb.* 2004, 56.

Partij	Onder-tekening	Ratifi-catie	Type ¹⁾	In werking	Opzeg-ging	Buiten werking
Algerije		20-08-01	T	20-11-01		
Antigua en Barbuda		25-08-99	T	03-02-00		
Argentinië		02-09-93	T	03-02-00		

Partij	Onder- tekening	Ratifi- catie	Type ¹⁾	In werking	Opzeg- ging	Buiten werking
Australië		07-02-97	T	03-02-00		
Azerbeidzjan		16-07-97	T	16-10-04		
Bahama's		02-02-99	T	03-02-00		
Bahrein						
Bangladesh		18-12-02	T	18-03-03		
Barbados		11-08-00	T	11-11-00		
Bulgarije		04-06-04	T	04-09-04		
Cambodja		08-06-01	T	08-09-01		
Chili		03-03-95	T	03-02-00		
China	23-02-90	03-02-95	R	03-02-00		
Cuba		25-10-05	T	23-01-06		
Cyprus	09-03-89	04-02-98	R	03-02-00		
Denemarken		02-12-91	T	03-02-00		
Dominica		21-06-00	T	21-09-00		
Duitsland		22-06-95	T	03-02-00		
Egypte		21-04-95	T	03-02-00		
Equatoriaal Guinee		24-04-96	T	03-02-00		
Eritrea		04-02-00	T	04-05-00		
Estland		03-07-02	T	03-10-02		
Fiji-eilanden		28-07-04	T	28-10-04		
Finland		17-12-99	T	17-03-00		
Frankrijk	23-01-90	05-10-90	R	03-02-00		
Grenada		28-06-04	T	28-09-04		
Griekenland	13-02-90	19-07-94	R	03-02-00		
Hongarije		17-04-03	T	17-07-03		
Ierland		07-05-02	T	07-08-02		
IJsland		12-05-00	T	12-08-00		

Partij	Onder- tekening	Ratifi- catie	Type ¹⁾	In werking	Opzeg- ging	Buiten werking
India		10-08-00	T	10-11-00		
Italië		18-04-91	T	03-02-00		
Jamaica		02-05-03	T	02-08-03		
Japan		24-06-97	T	03-02-00		
Jordanië		14-10-03	T	14-01-04		
Kroatië		31-01-00	T	30-04-00		
Letland		22-07-02	T	22-10-02		
Libanon		30-03-05	T	30-06-05		
Liberia		26-02-97	T	03-02-00		
Luxemburg		14-02-91	T	03-02-00		
Malawi		07-01-02	T	07-04-02		
Malta		28-01-99	T	03-02-00		
Marshall- eilanden, de		29-11-94	T	03-02-00		
Mauritius		17-12-02	T	17-03-03		
Mexico		13-05-94	T	03-02-00		
Moldavië		11-10-05	T	11-01-06		
Namibië		22-02-02	T	22-05-02		
Nederlanden, het Koninkrijk der	24-07-89	22-02-91	R	03-02-00		
Nicaragua		02-02-94	T	03-02-00		
Nieuw-Zeeland		06-03-01	T	06-06-01		
Noord-Korea		08-08-01	T	08-11-01		
Noorwegen		13-10-94	T	03-02-00		
Oman		17-06-91	T	03-02-00		
Pakistan		25-04-02	T	25-07-02		
Portugal		02-07-01	T	02-10-01		
Roemenië		18-05-01	T	18-08-01		

Partij	Onder- tekening	Ratifi- catie	Type ¹⁾	In werking	Opzeg- ging	Buiten werking
Russische Federatie		18-08-00	T	18-11-00		
Samoa		18-05-04	T	18-08-04		
Seychellen, de	26-09-89	27-09-89	R	03-02-00		
Sierra Leone		26-07-01	T	26-10-01		
Singapore		18-08-99	T	03-02-00		
Sint Kitts en Nevis		11-06-04	T	11-09-04		
Sint Lucia		20-05-04	T	20-08-04		
Sint Vincent en de Grenadines		09-10-01	T	09-01-02		
Slovenië		03-06-99	T	03-02-00		
Slowakije		30-01-95	VG	03-02-00		
Spanje		07-07-93	T	03-02-00		
Tonga		15-06-00	T	15-09-00		
Tsjechoslowa- kije (<01-01- 1993)		06-12-90	T			
Tunesië		13-01-99	T	03-02-00		
Tuvalu		08-07-04	T	08-10-04		
Uruguay	15-03-89					
Vanuatu		26-11-90	T	03-02-00		
Venezuela		18-11-98	T	03-02-00		
Verenigd Koninkrijk, het		08-03-00	T	08-06-00		
Verenigde Staten van Amerika, de	06-04-89	01-07-91	R	03-02-00		
Vietnam		27-05-02	T	27-08-02		
Zuid-Korea		14-11-94	T	03-02-00		
Zweden	28-02-90	04-02-93	R	03-02-00		

¹⁾ DO=Definitieve ondertekening, R=Ratificatie, aanvaarding, goedkeuring of kennisgeving, T=Toetreding, VG=Voortgezette gebondenheid

Uitbreidingen

China

Uitgebreid tot	In werking	Buiten werking
Hong Kong SAR	23-10-2002	

Verenigd Koninkrijk, het

Uitgebreid tot	In werking	Buiten werking
Bermuda	30-01-2004	
Britse Maagden-eilanden	10-06-2004	
Cayman-eilanden	30-01-2004	
Falkland-eilanden	19-05-2004	
Gibraltar	30-01-2004	
Jersey	19-05-2004	
Man	30-01-2004	
Sint Helena	10-06-2004	
Turks- en Caicos-eilanden	07-07-2004	

Verklaringen, voorbehouden en bezwaren

Bahrein, 27 april 2000

Protocol of 1988 relating to the International Convention on Load Lines, 1966 and the Protocol of 1988 relating to the International Convention for the Safety of Life at Sea 1974 as amended.

1. In relation to IMO Assembly Resolution A.883 (21) adopted on 25 November 1999, the Government of the State of Bahrain intends to join the Protocol of 1988 relating to the International Convention of Load Lines, 1966, and the Protocol of 1988 relating to the International Convention for the Safety of Life at Sea, 1974 as amended.

2. Pursuant to paragraph 2 of the above mentioned resolution, the Government of the State of Bahrain confirms that it hereby accept and implement the harmonised system of survey and certification as from 3 February 2000, and will issue certificates in the form prescribed by the 1988 Solas and Load Line Protocols as modified in accordance with Annex 2 to the said resolution.

G. INWERKINGTREDING

Zie *Trb.* 2004, 56.

Resolutie MSC.143(77) van 5 juni 2003

De wijzigingen zijn ingevolge artikel VI, tweede lid, onderdeel g, (ii) van het Protocol op 1 januari 2005 in werking getreden aangezien minder dan één derde van de Verdragsluitende Regeringen de Secretaris-Generaal vóór 1 juli 2004 schriftelijk heeft medegedeeld de wijzigingen niet te aanvaarden.

Wat betreft het Koninkrijk der Nederlanden, gelden de wijzigingen voor het gehele Koninkrijk.

J. VERWIJZINGEN

Zie *Trb.* 2004, 56.

Overige verwijzingen

Titel : Handvest van de Verenigde Naties; San Francisco,
26 juni 1945
Tekst : *Trb.* 1979, 37 (Engelse en Franse)
Trb. 1987, 113 (vertaling)
Laatste *Trb.* : *Trb.* 2004, 240

In overeenstemming met artikel 19, tweede lid, van de Rijkswet goedkeuring en bekendmaking verdragen heeft de Minister van Buitenlandse Zaken bepaald dat de wijzigingen zullen zijn bekendgemaakt in Nederland op de dag na de datum van uitgifte van dit Tractatenblad.

Uitgegeven de zesde februari 2006.

De Minister van Buitenlandse Zaken,

B. R. BOT