

Decarbonisation potential of synthetic kerosene

Final Report

E4tech (UK) Ltd for
Ministerie van Infrastructuur en Waterstaat

May 2021

Contents

1	Executive Summary	1
2	Introduction.....	8
2.1	Background	8
2.2	Objectives of study.....	8
2.3	Scope and approach to the study.....	9
3	Definition of routes and modelling approach	11
3.1	Definition of routes	11
3.2	Model definition.....	21
4	Results and analysis.....	25
4.1	Techno-economic modelling	25
4.2	Capacity ramp-up and feedstock modelling.....	42
5	Conclusions and implications	64
Appendix A	: Methodology for assessment of synthetic kerosene production potential	68
Appendix B	: Techno-economic modelling	78
Appendix C	: Descriptions of Water Gas Shift (WGS) and Reverse Water Gas Shift (RWGS)	87

E4tech (UK) Ltd

83 Victoria Street
London SW1H 0HW
United Kingdom

Tel: +44 20 3008 6140
Fax: +44 20 3008 6180

Incorporated in England and Wales

Company no. 4142898

Registered address:

133-137 Alexandra Road,
Wimbledon, London SW19 7JY
United Kingdom

www.e4tech.com

1 Executive Summary

Reducing emissions from aviation is an important policy aim for the Netherlands

The need to tackle climate change will require deep emissions reduction which is likely to affect all sectors of the economy, including air travel. This is an area of concern for the Netherlands, since international aviation is an important sector of the economy, as evidenced by higher than average share of aviation fuel in overall fuel consumption compared with other EU Member States. As a result, there is government interest in exploring innovative solutions to address the climate impacts of international aviation. In 2020, a Sustainable Aviation Agreement was adopted at the Sustainable Aviation Roundtable, which committed the Dutch government to a target of at least 14% of the aviation fuel bunkered in the Netherlands in 2030 being sustainable.

This study assesses the potential for synthetic kerosene to contribute to aviation decarbonisation

A range of options are available to produce lower carbon substitutes to fossil jet kerosene. Biofuel based on hydroprocessed esters and fatty acids (HEFA) is currently the most developed option, and while several other biofuel options have been certified for use, routes other than HEFA are either at the first-of-a-kind commercial, demonstration or earlier stages. In addition to bio-based routes, synthetic kerosene can be made from hydrogen produced from renewable electricity combined with CO and/or CO₂ from a range of sources. Non-renewable synthetic kerosene could also be produced using hydrogen from fossil sources, particularly natural gas with carbon capture and storage, and similar carbon sources.

The future potential of synthetic kerosene will be dependent on its cost competitiveness and ability to deliver significant GHG savings. Understanding the energy, GHG emissions and cost of synthetic kerosene production is therefore crucial to informing policy-making in this area. The processes required to convert hydrogen and carbon sources into synthetic kerosene, such as Fischer-Tropsch synthesis, benefit from large-scale implementation. How quickly production can be scaled up will partly determine the speed with which cost reductions can be achieved, making scalability and resource availability, including renewable electricity, critical to the competitiveness of synthetic kerosene routes.

The study has three principal objectives:

- Establish and compare the resource use (including energy), GHG emissions and production costs of different synthetic kerosene production routes;
- Examine, in the context of resource availability and competition for resources, the potential GHG savings that can be delivered and the abatement costs; and
- Evaluate the potential scale-up and availability of synthetic kerosene and business case that would underpin its commercialisation.

The scope of the study was to present the evidence relevant to these objectives in order to inform the policy debate, but the study specifically excludes any discussion of the policy implications of the evidence and findings. In line with this approach, the price of CO₂ has been ignored throughout this study both in terms of the cost of producing synthetic fuels from fossil sources and the effect on the

price of fossil kerosene. However, the GHG abatement costs calculated in this study provide an indicator of the level at which the carbon price would need to be set in order for synthetic kerosene to achieve cost parity with conventional fossil kerosene. In addition, the report does not assess where globally synthetic kerosene could be most cost-effectively produced or from which countries the most likely sources of supply would emerge.

Several routes have been modelled

This study models a range of synthetic kerosene routes including those using hydrogen from “green” (renewable power) and “blue” (abated natural gas) sources, along with CO₂ captured from biogenic and fossil point-sources or CO₂ from direct air capture (DAC). It also separately considers routes which use waste fossil CO from steel mills as an input, and these routes are referred to as recycled carbon fuels, not blue. Biogenic CO routes and routes involving hydrogen from biomethane have not been considered as part of this study. The routes are illustrated in the graphic below.

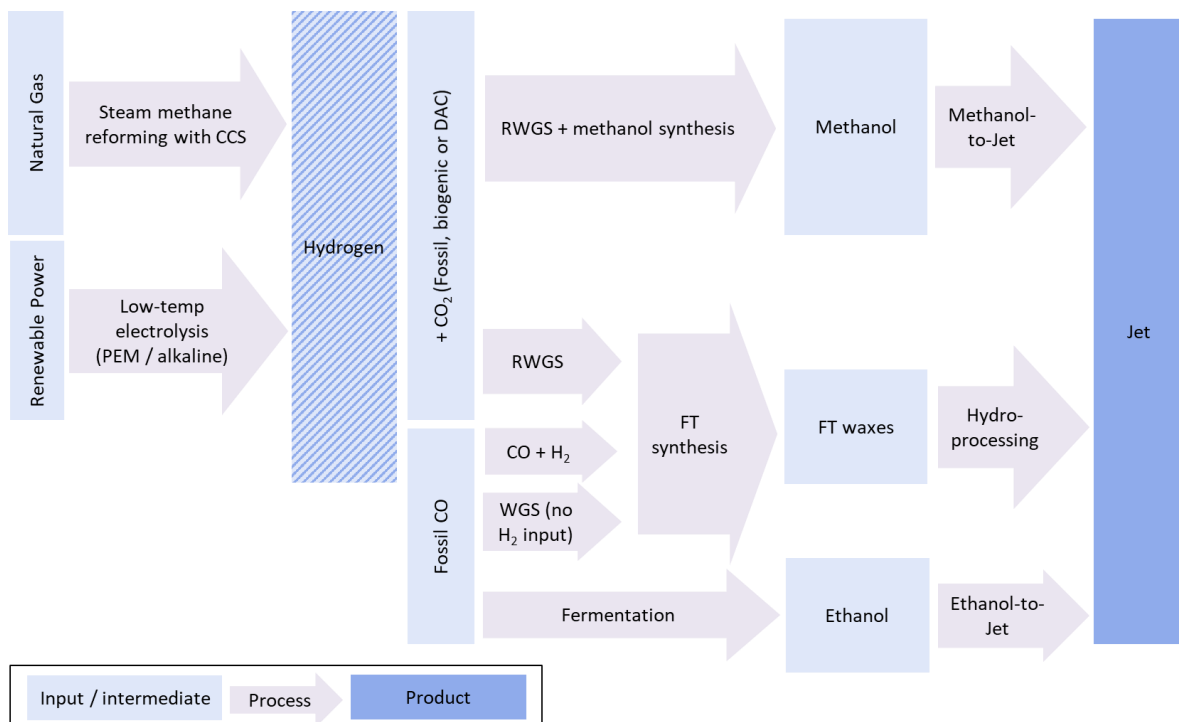

Figure 1: Production routes considered

A number of important conclusions have been drawn from the analysis carried out and these are set out in the following section:

Current costs are high for green routes, whereas blue routes offer a lower cost alternative today

The analysis shows that estimated costs of green synthetic jet fuel today would likely be very high, ranging from €4,300 – 6,800/tonne compared with pre-COVID fossil jet prices of around €600/tonne (assuming no carbon price is applied to fossil fuels). Costs for the methanol and FT routes are very similar, since the majority of the production cost is hydrogen, and both routes have similar hydrogen requirements. However, FT routes are ASTM approved and are more commercially mature than methanol to jet routes, which are yet to be ASTM certified.

Blue routes (where blue hydrogen is combined with CO₂) currently have a cost advantage over green routes, due to the lower cost hydrogen, but the cost of blue synthetic kerosene at €1,500 – 2,300/tonne is still significantly higher than the price of fossil jet. Note that routes using waste CO could be more competitive, as discussed below.

The most costly routes are those involving DAC, which is still to be commercialised, and requires significant energy inputs (which could be renewable, or supplied from power and gas grids). It is anticipated that the cost of DAC will fall considerably over time, reflecting learning rates, industrialisation of production and economies of scale. A faster ramp-up could accelerate these cost reductions.

Improving efficiencies and falling renewable power generation prices will see the cost of green and blue routes converge by 2050

While blue synthetic kerosene is shown to be cheaper than green today, a combination of factors will lead costs to converge over time. In 2050, the cost of green routes is in the ranges €1,500 – 2,000/tonne while blue routes are in the range €1,300 – 1,700/tonne. The biggest factor is the expected fall in renewable electricity costs, although improving electrolyser efficiencies and falling capital costs across the process chain as scales increase also play a role. However, rising natural gas costs also contribute to the convergence in costs, by limiting blue route cost reductions. This convergence could facilitate a transition from blue to green routes over time, especially as the imposition of any carbon price on fossil fuels would tend to reduce the competitiveness of blue routes relative to green.

However, even after cost reductions, in 2050 the cost of synthetic kerosene remains significantly above the price of fossil jet today, implying that there would need to be continued support for synthetic kerosene routes, or a carbon price on fossil fuels (assuming fossil jet prices were not to rise significantly over time).

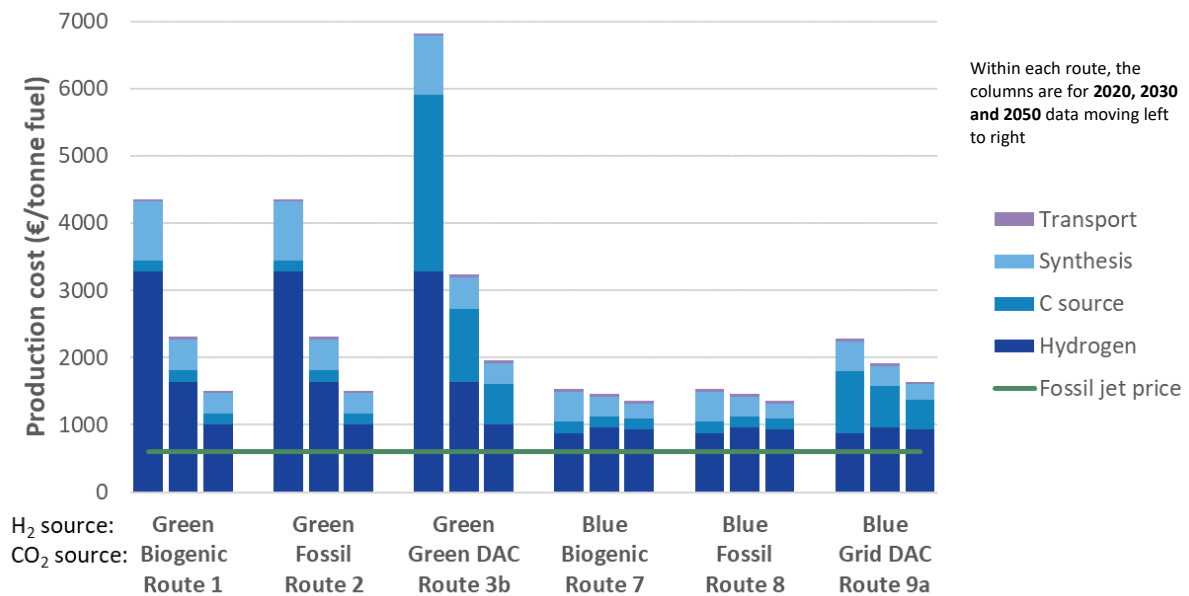

Figure 2: Production costs for CO₂ + FT synthetic kerosene routes by year

The GHG savings from blue routes are modest

While synthetic kerosene produced from blue hydrogen + CO₂ is likely to be less costly than fuel produced from green hydrogen + CO₂ today, it delivers only limited GHG savings. If synthetic kerosene based on blue hydrogen + CO₂ is deemed to have acceptable GHG savings and is adopted as an interim solution, it will be important to consider how this can transition from blue to green hydrogen over time in order to achieve Net Zero targets. Alternatively, blue hydrogen + CO₂ routes could be deemed to have insufficient GHG savings, and so might not be supported in policy.

Synthetic kerosene from blue hydrogen + CO₂ from DAC may actually lead to an increase in GHG emissions compared to fossil jet depending on the assumptions made about the source of heat energy for the DAC process (in this analysis, assumed to be high temperature DAC fuelled by natural gas). Emissions from blue hydrogen + CO₂ routes are in the range 50-113 gCO₂e/MJ_{LHV} today falling to 49-81 gCO₂e/MJ_{LHV} in 2050 (for comparison the REDII transport fossil fuel benchmark is 94 gCO₂e/MJ_{LHV}), with the routes employing biogenic point source CO₂ being the most attractive. This compares with 1-22 gCO₂e/MJ_{LHV} for the green hydrogen + CO₂ routes, although it is important to note the differences in underlying assumptions for DAC heating used in the blue and green routes. It should however be noted that biogenic point sources of CO₂ are likely to have limited availability and it is expected that the availability of fossil point sources of CO₂ will also decline over time due to policy.

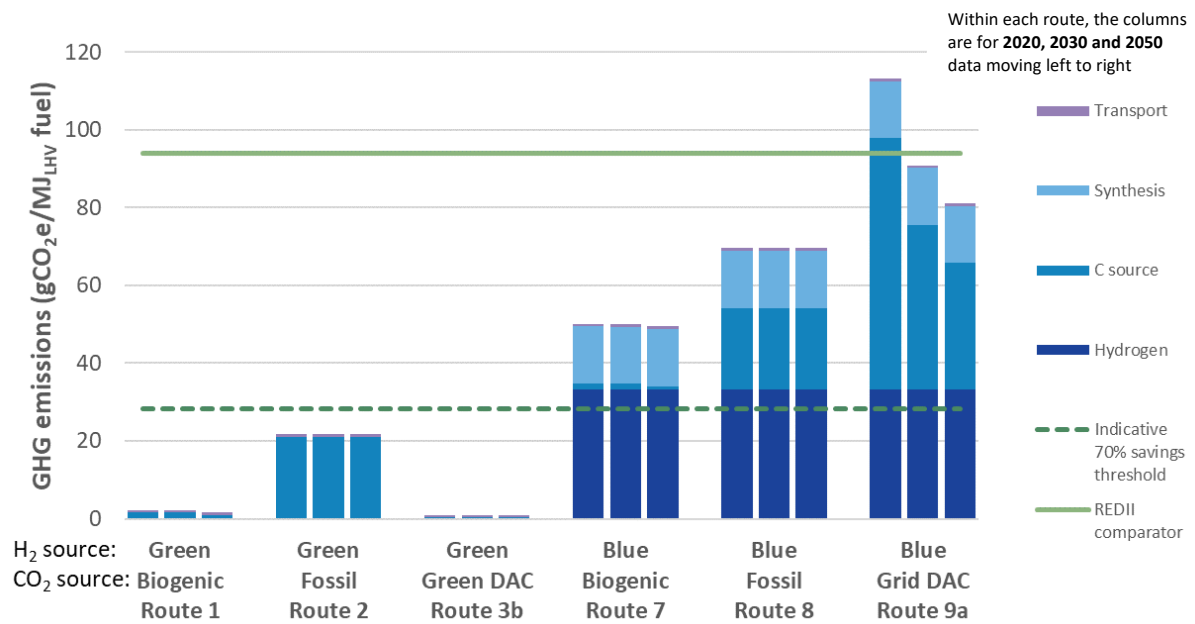

Figure 3: Lifecycle GHG emissions by FT route and year

GHG abatement costs are high initially but come into line with biofuel SAF routes over time

Both the green and blue synthetic kerosene routes have high GHG abatement costs today, reflecting the high costs of the green routes and the relatively poorer GHG performance of the blue routes. GHG abatement costs today are in the range €900 – 1,500/tCO₂e for green routes and €500 –

900/tCO₂e for blue (see Figure 26), but by 2050, green routes are expected to have lower abatement costs than blue routes, given falling costs. The CO based routes can have lower GHG abatement costs than the CO₂ routes, but only if the counterfactual¹ use of the feedstock is unabated.

By 2050, synthetic kerosene is expected to have GHG abatement costs in a similar range to SAF from other routes such as advanced biofuel routes (see Figure 43).

Routes which utilise CO rather than CO₂ could provide a relatively low cost option and GHG emissions savings for sites where waste CO is available and unabated

The use of recycled waste fossil (or biogenic) CO in the production of synthetic kerosene via Fischer-Tropsch is relatively attractive as the reverse water gas shift reaction required for CO₂ routes can be avoided. Fuel costs of around €1,000 – 1,300/tonne in 2030 could be achievable from fossil CO with associated emissions highly dependent on the feedstock counterfactual used. For example, for the CO + WGS route in 2030, synthetic kerosene net lifecycle GHG emissions of -137 gCO₂e/MJ_{LHV} (i.e. a very large GHG saving) could be achieved if the feedstock counterfactual is unabated power generation (see Figure 24), but emissions would be 75 gCO₂e/MJ_{LHV} if the counterfactual is abated power generation (see Figure 25). The equivalent figures for CO + blue H₂ are 27 gCO₂e/MJ_{LHV} and 96 gCO₂e/MJ_{LHV}, and for the CO fermentation + ATJ route they are 32 gCO₂e/MJ_{LHV} and 190 gCO₂e/MJ_{LHV} respectively in 2030 (see Figures 22 and 23).

While there are a number of large point sources of fossil CO available from industrial processes today, these may not be as geographically dispersed as CO₂ sources, potentially limiting the locations where this technology could be used. Fossil CO volumes are not limited today, but could be expected to reduce in availability over time as processes such as steel production decarbonise (e.g. switching from coking coal to technologies such as direct reduced iron). Since the FT process is indifferent to the source of syngas, CO based plants could transition from fossil CO to biogenic CO or from blue to green hydrogen, or with some further investment, transition to use of CO₂ (although this has not been analysed in this study).

Methanol based routes show similar cost and GHG performance to FT alternatives

A full set of methanol to jet routes was explored using either green or blue hydrogen and the complete range of CO₂ sources. The cost and GHG performance of these routes was almost identical to the results obtained for the FT routes. We conclude that any preference for one approach over the other would be driven by operational considerations rather than cost or carbon reduction potential. For example, methanol can be used as a fuel directly, as an input to other fuels including synthetic kerosene and as an intermediate input to products such as plastics; this market flexibility may be considered an advantage by some producers and may allow economies of scale to be realised.

¹ A “counterfactual” is defined as an alternative use for fossil feedstocks, e.g. CO from steel mills would otherwise be used for unabated or abated power generation if it were not used to produce synthetic kerosene, and so displaced emissions (e.g. from reduced power export to the grid) should also be accounted for in the synthetic kerosene GHG emissions. This counterfactual differs from the RED II fossil “benchmark” value of 94gCO₂e/MJ_{LHV} against which a fuel’s lifecycle GHG emission savings are calculated.

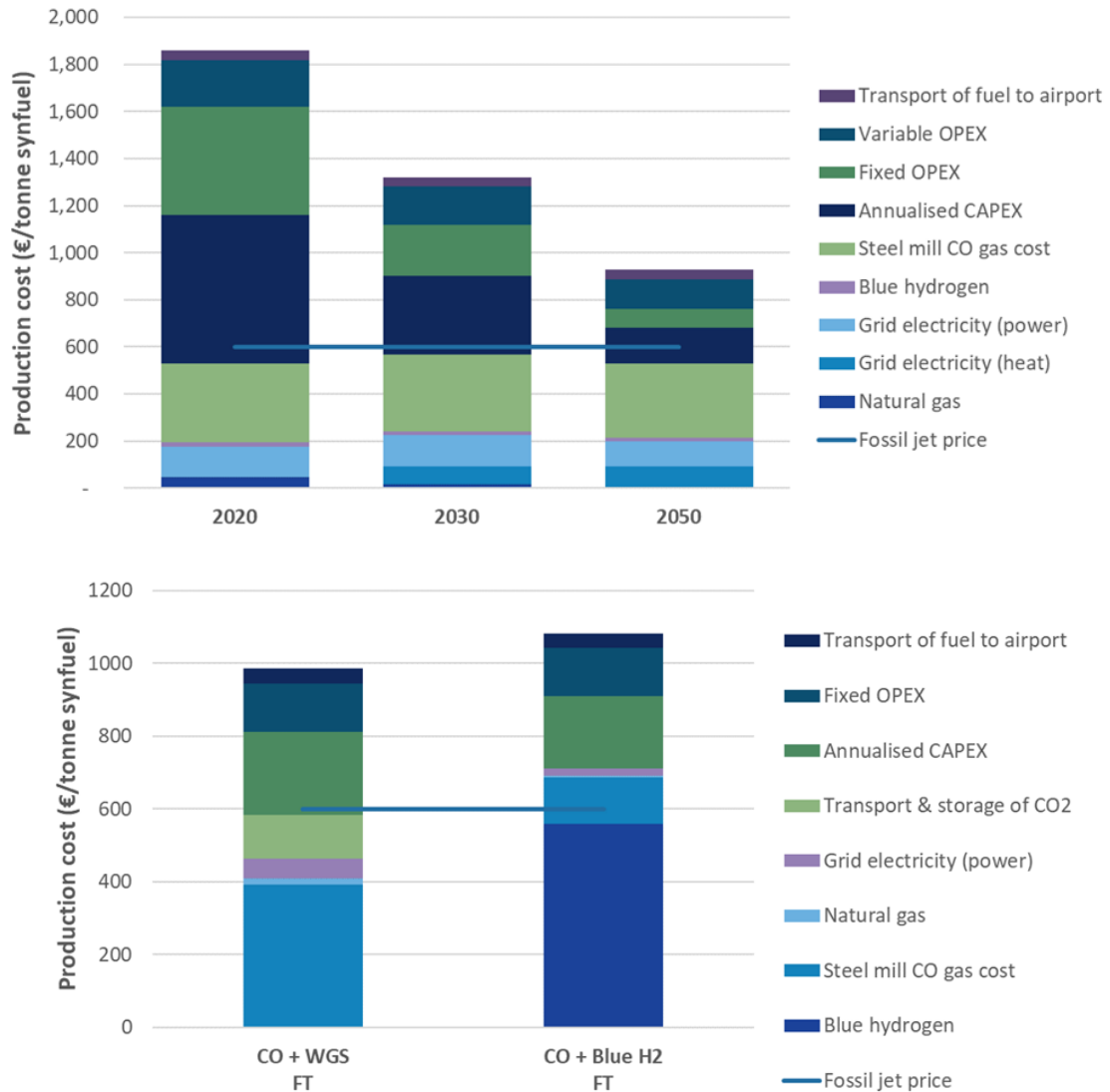

Figure 4: Production costs for CO-based synthetic kerosene routes (top chart: LanzaTech route 13 and bottom chart: CO + FT routes 14-15 in the year 2030 only)

Capacity scale-up could be rapid and make a contribution to the Netherlands’ SAF objectives

The capacity build up modelling carried out for this study suggests that supply could reach 966 ktonnes/year in Europe by 2030, and 28 Million tonnes/year by 2050 if the majority of global activity were to remain in Europe. At global scale, synthetic kerosene deployment could reach 1.3 Million tonnes/year in 2030 and 36.7 Million tonnes/year by 2050. Synthetic kerosene routes could therefore materially contribute to overall SAF supplies.

A review of feedstock availability suggests that based on this capacity build up, feedstock potentials are unlikely to restrict the rate at which capacity of any of the routes considered can be rolled out. However, specific local constraints (e.g. on carbon sequestration or supply of renewable electricity) could affect the speed of roll out.

Whilst transitions or energy system modelling have not been examined in this study, an approach to developing synthetic kerosene that allows the use of both green and blue routes could potentially accelerate scaling up of the whole synthetic kerosene industry, with blue shifting to green hydrogen

supplies over time – although blue routes may have to meet certain GHG savings thresholds to be deemed acceptable.

Blue hydrogen production at scale would be consistent with the optimal scale for fuel synthesis, but is dependent on CCS infrastructure, and fossil infrastructure lock-in risks and continued emissions need careful consideration. Green routes, while currently significantly more expensive, have very low emissions, do not necessarily rely on CCS infrastructure, will benefit from rapidly decreasing renewable power costs, and could contribute to balancing increasing renewable power on the grid. Recycled fossil CO sources could be utilised for jet fuel production in the near to mid-term, but the need to avoid fossil emissions means that steel mills and other industries will increasingly decarbonise towards 2050, limiting the availability of these routes, and requiring switching of the jet synthesis plant to other feedstocks (either biogenic CO, green H₂ and/or non-fossil CO₂ sources).

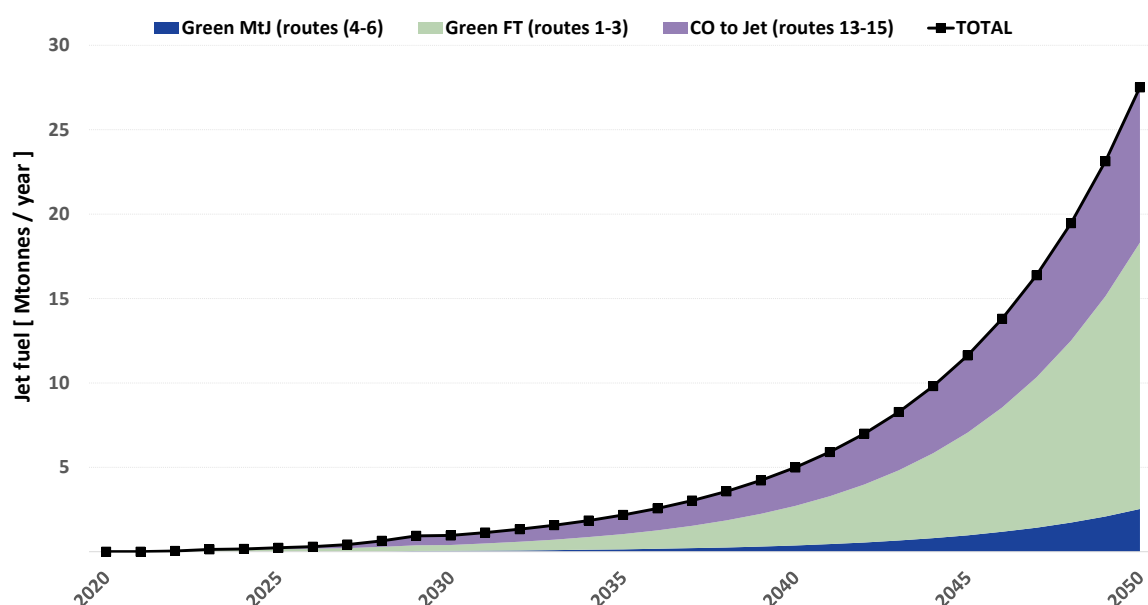

Figure 5: Route breakdown of synthetic kerosene in Europe to 2050 under the fast growth scenario

Further possible areas of investigation include a more detailed analysis of Net Zero compatible pathways and assessment of alternative electrolysis routes

A valuable area of further investigation would be around Net Zero compatible transition pathways, and how quickly the sector will have to transition from the use of point fossil sources of CO₂ and/or blue hydrogen to routes that use DAC or biogenic CO₂ in conjunction with green hydrogen. This should include consideration of the relative merits of different routes, including both FT and methanol options. A more structured pathway analysis including timeframes, phase out/phase in transitions and total cumulative GHG savings would be useful in developing a roadmap for the development of synthetic kerosene.

A number of additional technologies are under development or consideration which have not been considered in this analysis, e.g. high temperature solid oxide electrolysis and CO₂ co-electrolysis, and these could be explored in more detail. Some of these technologies offer promise, e.g. in terms of improved efficiency, so support for their research and development could help them to achieve commercial readiness more quickly.

2 Introduction

2.1 Background

Lower carbon, sustainable aviation fuels (SAF) are expected to play an important role in reducing aviation GHG emissions, and international and national policies are being developed to reduce aviation GHG emissions from the aviation sector. This includes the Netherlands' draft Civil Aviation Policy Memorandum 2020-2050 which aims to set GHG emissions reduction targets and to mandate the use of renewable fuel by 2023, if no mandate is set at EU level.

The aviation industry will continue to be heavily reliant on energy-dense kerosene fuels. Today SAF is seen as the most promising solution to decarbonise the aviation sector. Alternative technologies are either not suited to service medium-long haul flights (e.g. electrification) or are still a long time away from realisation and commercial deployment (e.g. hydrogen). Significant capacity ramp up of SAF fuels will be needed to achieve the climate targets of the aviation industry.

A range of options are available to produce low carbon substitutes to fossil jet kerosene. Biofuel based on hydro-processed esters and fatty acids (HEFA) is currently the most developed option, although long-term feedstock supplies are likely limited. While several other biofuel options have been certified for use, routes other than HEFA are either at the first-of-a-kind commercial, demonstration or earlier stages.

In addition to bio-based routes, synthetic kerosene can be made from hydrogen produced from renewable electricity combined with CO and/or CO₂ from a range of sources e.g. fossil, biogenic or atmospheric (synthetic kerosene). Non-renewable synthetic kerosene could also be produced using hydrogen from fossil sources, particularly natural gas with carbon capture and storage, and similar carbon sources. These synthetic routes are less developed than the bio-based SAF routes, but interest in their potential has been growing, linked to the interest in renewable and low carbon hydrogen, and it is these routes that will be the focus of this report.

In addition to technical feasibility, other factors such as regulatory, logistical and commercial aspects affect the large-scale deployment of synthetic kerosene fuels, and the future potential of synthetic kerosene will be dependent on its cost competitiveness and ability to deliver significant GHG savings. Understanding the energy, GHG emissions and cost of synthetic kerosene production, the rate at which its production could be scaled up and the resources required is therefore crucial in informing policy-making in this area.

2.2 Objectives of study

The overall aim of this study is to evaluate the energy, emissions and economic performance of synthetic kerosene production, and to analyse its scalability. The specific objectives of the study are to:

- Establish and compare the resource use, including energy, GHG emissions and production costs of different synthetic kerosene production routes;
- Assess the potential GHG savings that can be delivered and the abatement costs; and
- Evaluate the potential for scale-up and availability of synthetic kerosene, taking into consideration resource availability, and the requirements for commercialisation.

In addressing these objectives, a picture will be developed of how the use of synthetic kerosene could help the Netherlands achieve its 2030 SAF target, and how synthetic kerosene could support the achievement of any SAF mandate envisaged by the EU.

2.3 Scope and approach to the study

To realise the objectives set out in Section 2.2, this study was conducted in two parts. The first part focused on techno-economic and emissions modelling, while the second part considered resource availability and capacity ramp-ups:

- Task 1 estimated the energy and feedstock requirements, GHG emissions and costs of synthetic kerosene production and discusses the implications in terms of emissions savings, abatement cost and business cases.
- Task 2 assessed the sustainable scale-up potential and availability of synthetic kerosene in the short term (2030) with an outlook for the longer term (2050), taking into account potential resource availability constraints.

The production routes considered in this study are set out in Table 1 grouped according to the key synthesis process.

Table 1: Description of routes and processes considered in this study

Source of H ₂ \ Source of carbon	Biogenic CO ₂	Fossil CO ₂	Fossil CO	Direct Air Capture (DAC)
“Green” hydrogen from renewable electrolysis	1. RWGS + FT synthesis to jet 4. Methanol synthesis + methanol to jet	2. RWGS + FT synthesis to jet 5. Methanol synthesis + methanol to jet		3. RWGS + FT synthesis to jet 6. Methanol synthesis + methanol to jet
“Blue” hydrogen from natural gas reforming with CCS	7. RWGS + FT synthesis to jet 10. Methanol synthesis to methanol to jet	8. RWGS + FT synthesis to jet 11. Methanol synthesis to methanol to jet	15. FT synthesis to jet	9. RWGS + FT synthesis to jet 12. Methanol synthesis + methanol to jet
Water			13. CO fermentation to ethanol to jet 14. CO WGS + FT synthesis to jet	

Other routes such as biogenic CO routes, or biomethane reforming, have not been considered within the scope of this study, but could be studied in future work. Figure 6 illustrates the production routes from Table 1 in graphical form. The routes are discussed in more detail in Section 3.

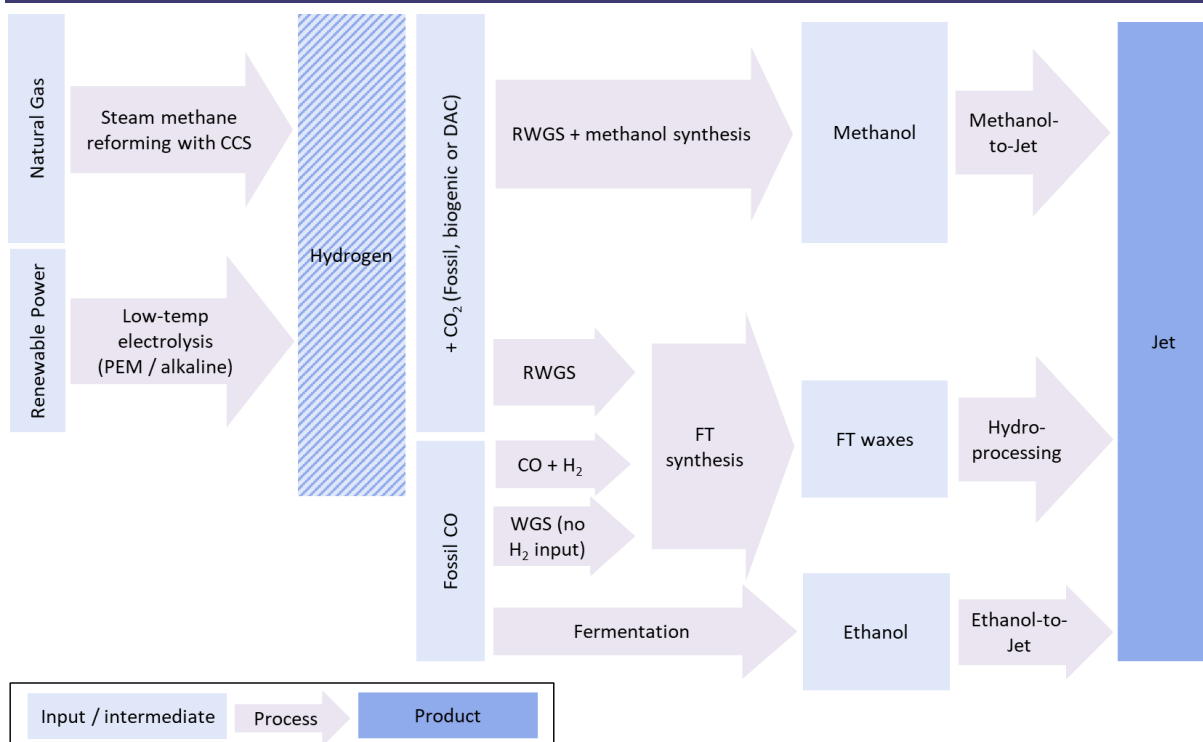

Figure 6: Production routes considered

It should be noted that a number of additional technologies are under development or consideration which have not been considered in this analysis. Notably, earlier stage technologies such as high temperature solid oxide electrolysis or CO₂ co-electrolysis have been excluded from the study. Some of these technologies offer promise, e.g. in terms of improved efficiency, so support for their research and development could help them to achieve commercial readiness more quickly.

Each of the routes has different considerations in terms of resource availability, sustainability and scale-up potential, which needed to be analysed as outlined below:

- **Current status of routes.** What is the current status of the selected synthetic kerosene routes and what are the high level challenges to scale-up and deployment? What current and planned projects are in the pipeline and what is their production capacity? Which players are active in the industry?
- **Short and long term outlook.** What are the expectations in terms of capacity scale-up in the short and long-term based on bottom-up scenarios to 2030, and extrapolation using growth rates to 2050?
- **Resource availability considerations.** What are the feedstock requirements for the routes, how quickly can these be scaled up to underpin the capacity development and what competition might exist between these resources, especially renewable electricity for green routes or CCS infrastructure for natural gas routes? Note that when considering the resource implications, these routes are grouped into four principal classes of technology which share common feedstocks.

3 Definition of routes and modelling approach

3.1 Definition of routes

3.1.1 Renewable electrolysis + Fischer-Tropsch (Routes 1-3)

Routes 1, 2 and 3 involve renewable electrolysis to produce hydrogen which is then combined with CO₂ in a reverse water-gas-shift (RWGS) reaction to produce the syngas needed for FT synthesis.

Green hydrogen can be produced from renewable electricity via **electrolysis** of water. Low temperatures systems either use a Polymer Electrolyte Membrane (PEMEL) or alkaline (AEL) electrolyser. PEMEL is commonly considered as it has fast start-up times and better part load performance than AEL which makes it more suited for use with intermittent renewables. However, PEMEL capital costs are higher than for AEL, and AEL technology is much more established. An alternative could be high temperature Solid Oxide Electrolyser (SOE), given its higher electrical efficiency due to the use of input heat. SOE may have lower capital costs than PEMEL, but SOE costs and lifetimes/degradation profiles are more uncertain given their lower level of maturity.

A variety of CO₂ sources can be used, such as, **biogenic point sources** (*biomass power plants, biogas upgrading, fermentation to alcohols*), **fossil point sources** i.e. industry/power sector emissions (*gas power/CHP plant emissions, cement and steel plant emissions*), or Direct Air Capture (**DAC**) from the atmosphere. Point sources of CO₂ vary in their purity and pressure, but typically can be captured at relatively low cost with the input of some heat and power. By comparison, DAC plants involve greater capital outlay and high inputs of heat and/or power, and are a significantly higher cost CO₂ source given the scarcity of CO₂ in the atmosphere. These CO₂ sources are common across all the different routes.

CO₂ is converted to CO using some of the renewable H₂ in the **RWGS reaction** and combined with further renewable H₂ to produce syngas (H₂ and CO) which is the input required for FT synthesis.

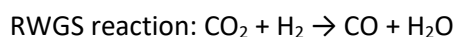

FT synthesis produces syn-crude, a broad mix of hydrocarbons containing light gas (C1-C4), naphtha, middle distillates, light waxes and heavy waxes.

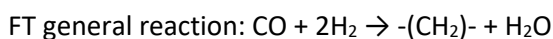

This is followed by a **distillation** step where the gases, water and FT liquids produced from the FT reactor are separated. Hydrogen can then be used to catalytically reduce the size of large hydrocarbons (waxes) into more useful, narrower carbon number range fractions (**hydrocracking**).

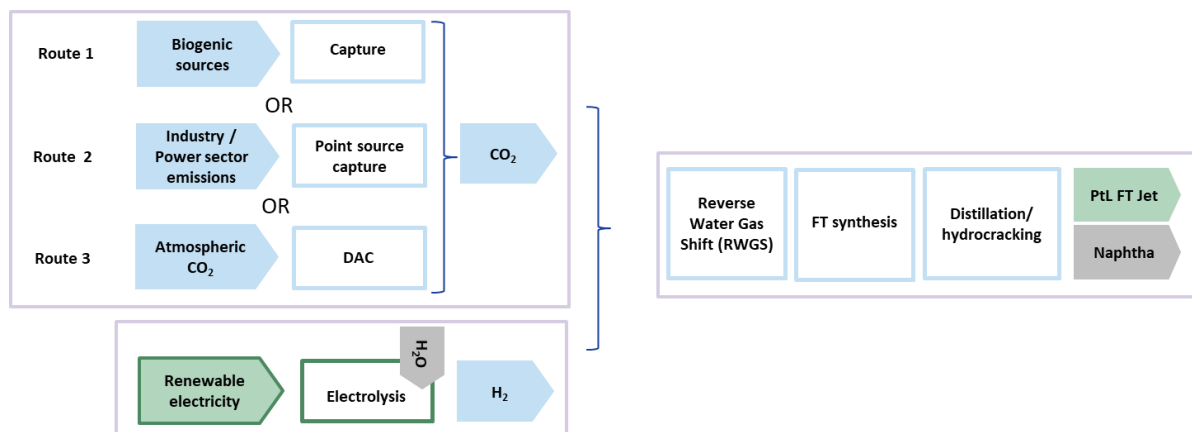
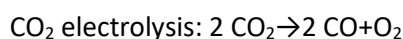
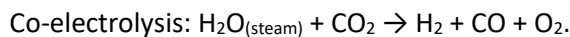

Figure 7: Value chain for renewable electrolysis + RWGS + FT synthesis from CO₂

As an alternative to the RWGS reaction, electrolysis can also be used to convert CO₂ to CO. A PEM electrolyser or solid oxide electrolyser can be used. CO₂ electrolysis technology are at around TRL 6-7 as Haldor Topsøe has a demonstration SOEC unit² and Opus 12 has developed some demonstration PEM units.



Alternatively, a solid oxide electrolyser operating in co-electrolysis mode could be used to enable the simultaneous splitting of H₂O and CO₂. However, this is still at an earlier development stage at around TRL 5. Sunfire are the main actor looking to develop PtL projects using co-electrolysis technology.



The electrochemical reduction of CO₂ to CO (via electrolysis or co-electrolysis) is less commercialised than RWGS, and has therefore not been considered in this study's cost, GHG emissions and energy efficiency analysis. However, these alternative technologies could have potential in terms of reducing system complexity and costs, and could be explored further in future work.

Technology and Commercial Readiness

The combined electrolysis, RWGS and FT process is currently at TRL 5-6, with its use in pilot and demonstration plants, although scales are ramping up with some large projects announced. The readiness of the RWGS process depends upon scale: small scale RWGS is at TRL 7, while large scale RWGS processes are at TRL 5-6, as scaling up is difficult due to the risk of coke formation in larger plants. FT synthesis of syngas and hydrocracking are widely established processes and are at TRL 9.

From a commercial standpoint, electrolysis + RWGS + FT synthesis is proven at demonstration scale, and projects are planned at commercial scale (TRL 7), but current production costs are high³. This is mainly due to electricity costs, electrolyser CAPEX, and the fact that downscaling FT equipment to match electrolyser sizes negatively affects the capital cost per unit of fuel produced. Electrolyser plants are expected to reach gigawatt scale over time, by connecting multiple electrolyser modules together, tending to reduce or eliminate this optimal fuel synthesis scale mismatch.

² Haldor Topsoe (2017) Small-scale CO from CO₂ using electrolysis
<https://www.topsoe.com/hubfs/2115834/CAMPAIGNS/eCOs/Haldor%20Topsoe%20India%20article.pdf>

³ Brynolf, Selma, et al. "Electrofuels for the transport sector: A review of production costs." *Renewable and Sustainable Energy Reviews* 81 (2018): 1887-1905. <https://www.sciencedirect.com/science/article/abs/pii/S1364032117309358>

Table 2: Summary of renewable electrolysis + FT synthesis from CO₂ plants

Project	Location	Electrolyser	FT Synthesis	Scale (thousand litres/yr)	Products	Timeline
Sunfire/Audi PtL plant	Dresden, Germany	Sunfire (SOEL 10kWe)		3.7	e-Gasoline e-Diesel e-jet	Started operation in 2014, now concluded
Soletair Pilot Plant	Lappeenranta, Finland	N/A (PEM 5kWe)	INERATEC (RWGS) VTT (FT MOBSU)	0.7	e-Gasoline	Started operation in 2017, now concluded
ICO2CHEM	Frankfurt, Germany	N/A (Chlor-alkali, kWe scale)	INERATEC (RWGS, FT Synthesis) VTT (FT Co-based)	1.5	Chemicals (white oils and high weight waxes)	Planned to start in 2020
Technical University of Hamburg (GP2J)	Stade, Germany	N/A	N/A	N/A	e-jet e-Diesel	Construction scheduled from 2022. Plan announced in April 2019
Copenhagen Airports, Maersk, DSV Panalpina, DFDS, SAS, Ørsted	Copenhagen, Denmark	Stage 1: 10 MWe Stage 2: 250 MWe Stage 3: 1300 MWe	N/A	Stage 1: 2,400 Stage 2: 48,00 Stage 3: 312,000	Methanol; Jet, Road and Marine diesel	Each stage could be operational by: Stage 1: 2023 Stage 2: 2027 Stage 3: 2030
Zenid	Rotterdam, The Netherlands	Sunfire, Climeworks (DAC)	INERATEC	320 – 1,280	e-jet	2023 construction proposed. Currently in review of FEED phase.
Norsk e-Fuel	Herøya, Norway	Sunfire (co-electrolysis), Climeworks (DAC)		10,000 (by 2023), 100,000 (by 2026)	FT waxes to be refined to e-Gasoline, e-Diesel, e-jet	Planned commissioning in 2023
Nordic electrofuel (was Nordic Blue Crude)	Herøya, Norway	TBC (Alkaline electrolyser)	TBC	10,000	FT waxes to be refined to e-Gasoline, e-Diesel, e-jet	FEED study underway
Kopernikus Project (Phase 2)	KIT, Karlsruhe, Germany	Sunfire (co-electrolysis), Climeworks (DAC)	INERATEC	73	e-Gasoline e-Diesel e-jet	Plans for 2022 start announced in April 2019

3.1.2 Renewable electrolysis + Methanol to jet (Routes 4-6)

Methanol can be produced from CO₂ sources in either one or two catalytic steps. The conventional route for methanol production involves a two-step process in which the RWGS reaction is first used to convert CO₂ to CO in the RWGS reaction, which is then combined with H₂ to make syngas, and reacted to form methanol. However, more recently direct synthesis routes are being explored which involve the direct reaction of hydrogen with CO₂ to produce methanol and water, requiring different reactor designs. Technology developer Carbon Recycling International (CRI) is pursuing this route, given the potential for enhanced methanol selectivity and reduced energy consumption.

Methanol can then be upgraded into longer chain chemicals and fuels, for example via a process optimised for the production of molecules in the jet fuel range. Methanol-to-Jet synthesis first uses the Methanol-to-Olefins (MtO) process. The produced olefins (e.g. ethylene and propylene) are then oligomerised to form straight chain paraffinic hydrocarbons, which are subsequently fractionated. Depending on the selectivity of the oligomerisation step, hydrogenation and/or isomerisation may be needed prior to distillation to meet jet product specifications.

The route via methanol has the advantage over FT in that intermediate storage of liquid methanol is simple, low cost and safe (compared to gaseous syngas or hydrogen storage). This also creates a buffer between variable renewable power inputs, and the downstream methanol refining process which operates best at continuous loads. Methanol also offers the possibility to develop the synthetic fuel project in phases, by first setting up synthetic methanol supply chains (e.g. as a sustainable fuel for shipping) and in a second phase extending the project to the production of synthetic kerosene.

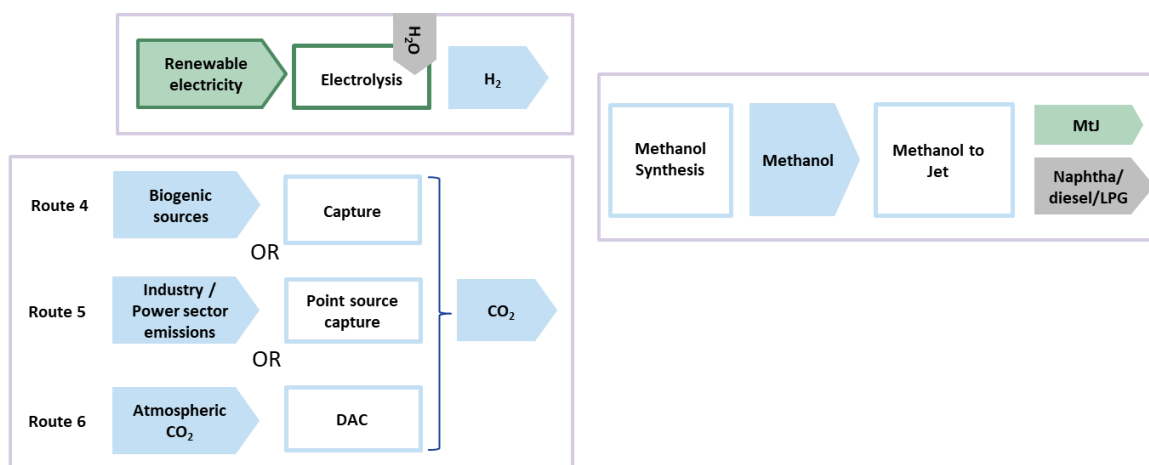

Figure 8: Value chains for Renewable electrolysis + Methanol + Methanol to jet route

Technology and Commercial Readiness

Although methanol production from syngas is commercially available (TRL 7-9) and has been for some time, **methanol production through catalytic synthesis of hydrogen and CO₂ is at TRL 7**, with a number of large-scale projects in the planning stages. The largest existing plant is the 5ML/year Carbon Recycling International plant in Svartsengi, Iceland, which uses dedicated geothermal electricity and CO₂ recovered from the geothermal power station as feedstocks.

Production costs are heavily influenced by electricity costs and remain high compared to other methanol production routes such as biomass/coal gasification or fossil gas reforming and catalysis⁴. The few operational projects are situated near renewable power plants in order to secure low-cost electricity and avoid grid fees, and are paired with carbon capture from point sources.

⁴ IRENA, 2019; Hydrogen: A Renewable Energy Perspective. https://www.irena.org/-/media/Files/IRENA/Agency/Publication/2019/Sep/IRENA_Hydrogen_2019.pdf

Table 3: Summary of CO₂ catalysis to methanol projects

Project	Location	Electrolyser	Methanol synthesis	Scale (million litres/yr)	Timeline
Patagonia Feasibility Study	Chile, Patagonia	Siemens (200Mwe)	N/A	139	N/A
Copenhagen Airports, Maersk, DSV Panalpina, DFDS, SAS, Ørsted	Denmark, Copenhagen	Stage 1: 10 Mwe Stage 2: 250 Mwe Stage 3: 1300 Mwe	N/A	Stage 1: 2.4 Stage 2: 48 Stage 3: 312	Each stage could be operational by: Stage 1: 2023 Stage 2: 2027 Stage 3: 2030
George Olah plant	Iceland, Svartsengi	N/A (6 Mwe alkaline)	Carbon Recycling International	5	Operational since 2012
MefCO2 project – Mitsubishi Hitachi Power Systems Europe	Germany, Niederaußem	Hydrogenics (1 Mwe PEME)	Carbon Recycling International	0.46	Operational since 2019
FreSMe project – Carbon Recycling International	Sweden, Luleå	None (CRI's ETL process uses by-product hydrogen)	Carbon Recycling International	0.014	Construction completed end of 2019, now in commissioning phase
E2Fuel project – MAN Energy Solutions	Germany, Haßfurt	Siemens (1.25 MWe PEME)	MAN Energy Solutions	Tbd	Project started in 2018. Plant start-up planned for 2021
Power2Met – GreenHydrogen	Denmark, North Jutland	GreenHydrogen (10-30 MWe)	Re::Integrate	10	Project started in 2019. Plant start-up planned for 2021
Westküste 100 project	Germany, Heide	Thyssenkrupp (30 Mwe planned to 2030)	Heide Refinery	-	30 MW _e (electrolyser) planned to 2025, scaling up to 700 MW _e by 2030
Me2Go project – Swiss Liquid Future (former Silicon Fire)	Switzerland	Thyssenkrupp (5 MWe)	Silicon Fire	5	Planned. Implementation agreement signed in 2018 to build 5 plants
Nouryon-led consortium	Netherlands, Delfzijl	McPhy (20 MWe alkaline)	BioMCN	N/A	Announced January 2020
Mider-Helm Refinery	Germany, Leuna	Sunfire (1 MWe)	Total/Helm AG	0.21	Production start-up in 2021
Liquid Wind – FlagshipONE	Sweden	Nel (alkaline)	Haldor Topsoe	55	Announced, planned to start production in 2023
INOVYN	Belgium, Antwerp	(NA)	INOVYN	10	Announced 2020

Although there is limited publicly available information on the methanol-to-jet route, this is likely to be based on commercially available technologies which will have to be adapted to this specific process. The MTO process has already been developed by a small group of technology developers (UOP, DICP, Sinopec and Lurgi)⁵. Both the UOP MTO and the Lurgi MTP processes have been used by several plants in China using coal-based methanol. In the second step, olefins are oligomerised to form straight chain paraffinic hydrocarbons, which are subsequently fractionated. This step would be

⁵ Gogate, 2019, "Methanol-to-olefins process technology: current status and future prospects", <https://www.tandfonline.com/doi/full/10.1080/10916466.2018.1555589#:~:text=The%20reactor%20and%20process%20conditions,0.3MPa%20and%20is%20exothermic.>

similar to an oligomerisation process licensed by Sud-Chemie or PetroSA, known as Conversion of Olefins to Diesel and Gasoline (COD)⁶.

Although the individual steps for this process are commercially available, no single licensor currently offers a complete end-to-end package, and it is unclear at what scale the integrated process has been tested: therefore the methanol-to-jet chain is estimated to be at TRL 4-5. Also, while the production of synthetic jet fuels through Fischer-Tropsch synthesis is certified under ASTM D7566, the methanol to jet route is not yet certified, and certification could take several years.

Currently only one consortium has been established with the objective to develop and demonstrate a methanol to jet pilot scale process, under the KEROSyn100 project⁷. This project is part of a portfolio of projects called "I100" aimed at developing a Power-To-X demonstration hub in the Heide region in Germany. KEROSyn100 brings together partners from industry and academia and received federal funding of €4.2 million. The developer claims that the process can be more selective towards jet than FT-processes. No details are given on the process configuration or catalysts, but these are likely to be analogous to those described previously. The current work on the KEROSyn100 pilot project suggests strong interest for an ASTM certification for the Methanol to Jet (MtJ) route.

3.1.3 Natural gas reforming + Fischer-Tropsch (Routes 7-9)

Routes 7, 8 and 9 involve steam methane reforming (SMR) with CCS to produce hydrogen, then the addition of external CO₂ supplies before a reverse water-gas-shift (RWGS) reaction to syngas, followed by FT synthesis. These routes involve taking carbon out of the methane feedstock, before adding carbon back in from an external source, so only make sense if transport of hydrogen and external CO₂ to the FT site is significantly more efficient and cheaper than transport of the external CO₂ to the SMR sequestration site. Otherwise, a cheaper and more efficient overall solution would be fossil gas to liquid (GTL) jet fuel production, along with sequestration of the point source or direct air capture CO₂. It is for this reason that the external CO₂ supply cannot come from other SMR plants, as this is effectively an inefficient fossil GTL process with high GHG emissions.

Steam Methane Reforming (SMR) is the principal hydrogen production method worldwide and involves the catalytic reaction of fossil natural gas with steam followed by a water-gas shift reaction to produce hydrogen and CO₂. The heat required is supplied externally, typically by burning natural gas/process streams onsite. The CO₂ from the reformer (around 60% of the input carbon) is at relatively high purity and pressure, and can be captured and sequestered at low cost. Process configurations in this study assume that the CO₂ from flue gases onsite are also captured at higher cost, raising total SMR plant CO₂ capture rates to around 90%. Note that the CO₂ needed for jet fuel synthesis is provided from another external source (typically a dilute CO₂ point source or via DAC).

Partial oxidation (POX) is an alternative non-catalytic process, in which the feedstock is gasified in the presence of oxygen before a water-gas shift reaction to produce hydrogen and CO₂⁸. While the operation of a POX reactor is less expensive than SMR, due to heat being produced instead of being required, the hydrogen yields are lower, making this route more expensive. POX is considered to be a

⁶ Halmenschlager, Cibele Melo, et al. "Oligomerization of Fischer-Tropsch tail gas over H-ZSM-5." *Industrial & Engineering Chemistry Research* 55.51 (2016): 13020-13031.

⁷ KEROSyn100 project, 2018, <https://www.heiderrefinery.com/en/press/press-detail/kerosyn100-taking-to-the-skies-with-green-fuel/>

⁸ Kalamaras, C., M., Efstathiou, A., M., 2013. Hydrogen Production Technologies: Current State and Future Developments. Available online at: <https://www.hindawi.com/journals/cpis/2013/690627/>

well-established TRL-9 hydrogen production method that can deliver a >99% CO₂ capture rate with pure oxygen used instead of air.⁹

Autothermal reforming (ATR) is a combination of both steam reforming (endothermic) and partial oxidation (exothermic) reactions⁸. In ATR, steam is added in a catalytic partial oxidation process⁸. ATR has the advantages of not requiring external heat and being simpler and less expensive than SMR, as well as having higher CO₂ capture rates⁸. Another advantage of ATR over SMR is that it can be shut down and started rapidly, while producing a larger amount of hydrogen than POX alone⁸. However, ATR plants typically need to be much larger than SMR plants for economic viability.

For the analysis, we focused on SMR as it is the largest route to hydrogen production in the EU in the present day. Other than the source of hydrogen, these routes are identical to those detailed in Section 3.1.1., in terms of the RWGS reaction, FT synthesis, distillation, and hydrocracking.

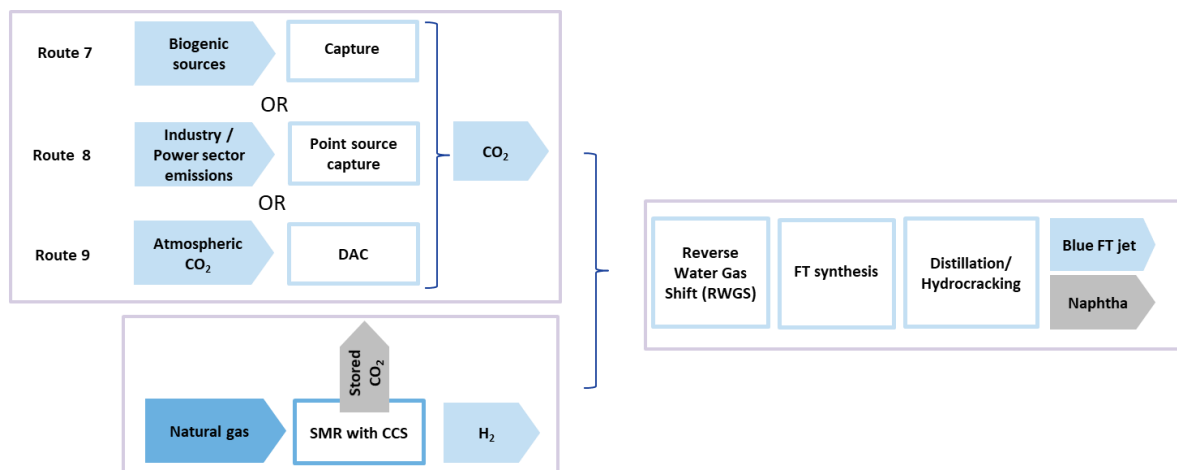

Figure 9: Value chain for SMR with CCS + RWGS + FT synthesis from CO

Technology and Commercial Readiness

SMR is at TRL 9, while CCS is currently at TRL 7-8 given a number of large demonstration and several first-of-a-kind commercial projects involving capture, pipeline and geological sequestration (although with a heavy focus on enhanced oil recovery). SMR+CCS is considered to be at TRL 7-8 given that Air Products has a CCS plant in Port Arthur, Texas, which has been operating for several years¹⁰. The whole route to jet fuel, i.e. SMR with CCS + RWGS + FT is currently **only at TRL 4-5**. There is no evidence of developers currently considering the entire chain mentioned above. This overall route is already certified under ASTM D1655, given the Fischer-Tropsch synthesis step.

3.1.4 Natural gas reforming + Methanol to jet (Routes 10-12)

The technology and processes involved in these value chains have already been described in sections 3.1.3 (reformation + CCS to produce hydrogen) and 3.1.2 (methanol synthesis and methanol to jet). As discussed above, these routes involve taking carbon out of the methane feedstock, before adding

⁹ Technology developer *Pers. Comm.*

¹⁰ IEA GHG, 2018. The CCS project at Air Products' Port Arthur hydrogen production facility. Available online at: <https://ieaghg.org/publications/technical-reports/reports-list/9-technical-reports/956-2018-05-the-ccs-project-at-air-products-port-arthur-hydrogen-production-facility>

carbon back in from an external source, so only make sense if transport of hydrogen and external CO₂ to the methanol site is significantly more efficient and cheaper than transport of the external CO₂ to the SMR sequestration site. Otherwise, a cheaper and more efficient overall solution would be fossil gas to methanol production (then methanol to jet), along with sequestration of the point source or direct air capture CO₂. It is for this reason that the external CO₂ supply cannot come from other SMR plants, as this would effectively be an inefficient fossil process with high GHG emissions.

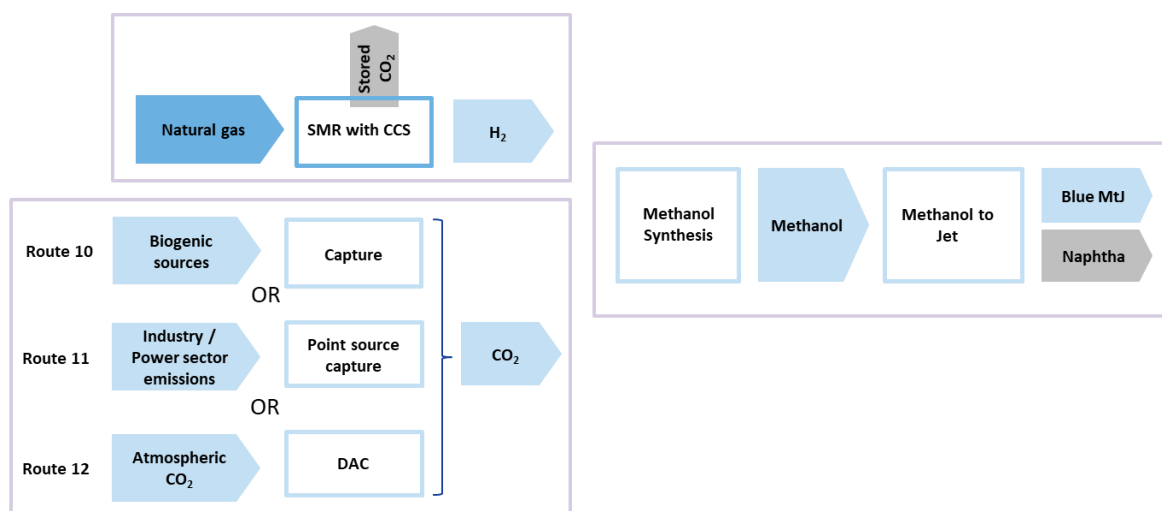

Figure 10: Value chains for SMR with CCS + Methanol + Methanol to jet route

At least three fossil methanol projects are currently operational that apply carbon capture and utilisation for enhanced fossil methanol production, but no projects currently involve methanol production using a source of blue hydrogen produced with CCS. There are also no known or planned projects including conversion of “blue methanol” into jet. Regarding technology readiness levels, SMR is at TRL 9 while CCS is at TRL 7-8, methanol production via RWGS reaction to syngas is at TRL 7-9, and methanol to jet is at TRL 4-5.

3.1.5 Steel mill gas fermentation + ethanol to jet (Route 13)

The syngas fermentation route using fossil off-gases containing carbon monoxide (CO) from steel mills has been pioneered by Lanzatech. In Lanzatech’s approach, the residual blast oxygen furnace gas stream from the steel mill is cooled, cleaned and injected into a fermentation vessel containing proprietary microbes and liquid media. The microbes grow by consuming the waste gases (typically mostly CO is consumed, but they are also being developed to utilise CO₂ and H₂). Ethanol and other chemicals are produced by these microbes and can be recovered from the fermentation broth.

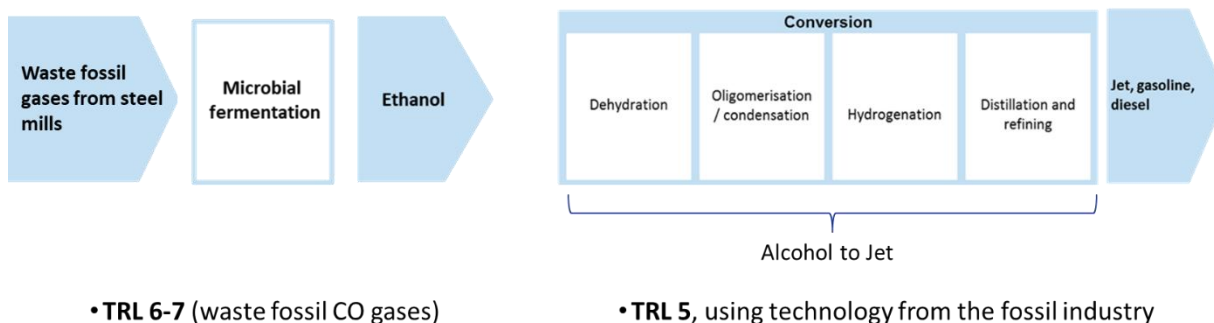

Figure 11: Steel mill gas fermentation to ethanol to jet route

The fermentation of steel mill gases to ethanol is currently at TRL 7-8, with first commercial plants in operation in China and under construction in Europe.

Table 4: Summary of steel mill gas fermentation to ethanol projects

Developer	Tech licensor	Location	Scale (million litres/yr)	Feedstock	Products	Status
Lanzatech + Shougang Group	Lanzatech	Hebei province, China	58	Steel mill gases	Ethanol	Operational since 2018
ArcelorMittal (Steelanol EU H2020 project)	Lanzatech	Ghent, Belgium	80	Blast furnace offgas	Ethanol	Under construction
Baowu Group, Lanzatech, Baosteel gases, Sinopec, Virgin Airline	Lanzatech	Shanghai, China	0.45	Waste gas from steel mill	Ethanol	Operational since 2017
Lanzatech– CSC - China Steel Cooperation	Lanzatech	Kaohsiung, Taiwan	127	Waste gas from steel mill	Ethanol	Operational since 2015
Lanzatech, Indian Oil Company (IOC)	Lanzatech	Panipat, India	40	Waste gas from steel mill	Ethanol	Announced
PNNL, Lanzatech, Imperium, Boeing	Lanzatech	US	0.01 ¹¹	Waste gas from steel mill	Jet fuel	Operational since 2015

Alcohol to jet technology is not yet in commercial use, though is based on technologies well known in the oil and gas industry. Short chain alcohols (ethanol, n-butanol, and isobutanol) are dehydrated to ethene or butene, which are then processed through oligomerisation reactions, followed by hydrogenation, isomerisation and finally distillation into the required product streams. Gasoline, diesel and jet can be produced, with the exact output depending on the process configuration. Currently operating at TRL 5, the alcohol to jet process could quickly reach a higher TRL given decades of prior industrial experience with the component technologies. The alcohol to jet process produces jet which has been ASTM approved for 50:50 blend with Jet-A.

¹¹ This is based on the following: LanzaTech scaled up the ATJ process, producing 4000 gallons of jet and 600 gallons of diesel for testing and a future proving flight (LanzaTech, n.d. A Hybrid Catalytic Route to Fuels from Biomass Syngas. Available online at: <https://www.osti.gov/servlets/purl/1423741>). Unit conversions: 1 US Gallon kerosene = 3.8 litres (Aqua-calc: <https://www.aqua-calc.com/calculate/volume-to-weight>)

3.1.6 Steel mill gas + Fischer-Tropsch (Routes 14 and 15)

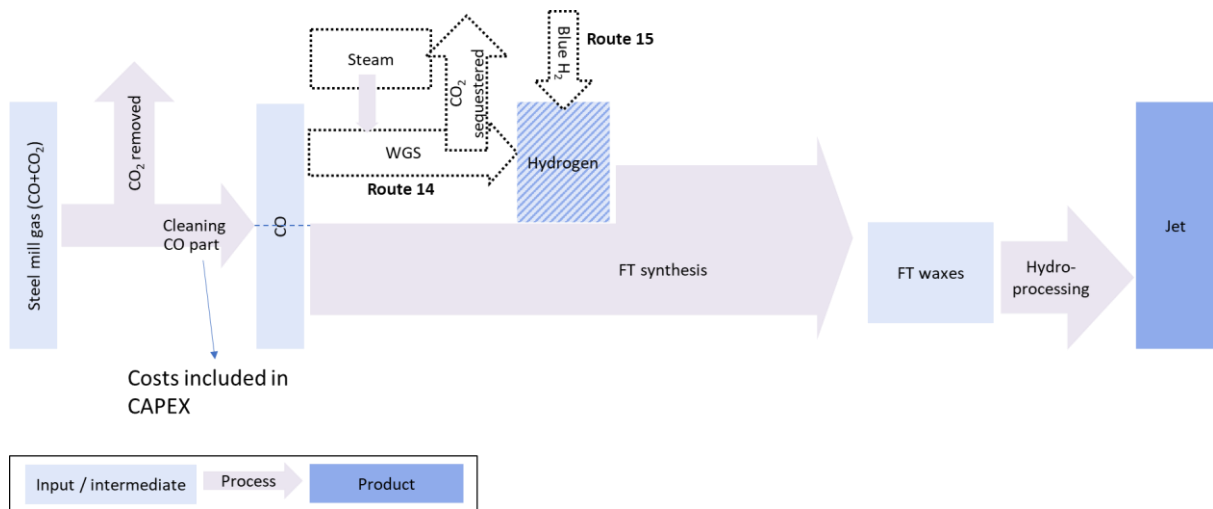

Figure 12: Value chains for conversion of steel mill gases to jet fuel via FT

Two possible routes are envisaged to take steel mill gases (CO) and catalytically convert them via FT to jet fuel (without the use of microbes). Steel mill gases typically contain a mix of CO, CO₂ and impurities. The small amount of CO₂ is first removed and then the resulting gas stream is cleaned to remove the impurities and produce high purity CO, as required for the downstream catalytic processes.

In route 14, roughly two thirds of the CO is reacted with steam in a WGS reaction to produce H₂ and CO₂ (CO + H₂O → CO₂ + H₂). The high purity CO₂ can then be captured at a very high capture rate and sequestered. The H₂ produced is combined with the remaining CO in a FT reactor to produce FT products, which are treated to produce jet fuel. As detailed in Section 3.1.1, hydrocracking reactions will be used to produce hydrocarbon chains with the specific chain lengths required for jet fuel.

In route 15, all the CO is combined with hydrogen from an external source in the FT reactor, avoiding the WGS reaction and the generation of CO₂ before FT synthesis.

At least one technology developer has commercial scale plans to use at least one of these two routes. Other than CCS (used directly in route 14, or in route 15 due to the external blue hydrogen production), each of the components are commercialised at TRL 9, although the overall system is currently at a lower TRL (estimated to be at around TRL 5 today). Routes 14-15 could therefore be rapidly built at commercial scale once CCS is available. The FT facility could also be modified to use green hydrogen (instead of blue hydrogen) or biogenic CO feedstocks (if these were available nearby or as steel mills switch from fossil CO to biogenic CO) later on which would help avoid lock-in or stranded fossil assets.

3.2 Model definition

3.2.1 Techno-economic modelling

A techno-economic model was developed and used to assess the synthetic kerosene routes presented in the previous section. The model provides estimates of overall energy efficiency, raw material inputs, GHG emissions and levelised costs for synthetic kerosene production for each route.

The model structure is shown in Appendix B, which illustrates the input data, intermediate products, synthesis steps and outputs. The routes are modelled with a modular approach in which unit processes (e.g. PEM electrolysis, DAC CO₂, RWGS, fuel synthesis) are combined to create each specific route. Each module takes costs (e.g. equipment, utilities), mass balances and energy balances as inputs. More detailed information can be found in Appendix B. A number of key assumptions were made when developing the model, as set out below.

Hydrogen production routes

Renewable hydrogen production uses data for a PEM electrolyser with a stack lifetime of 62,000 hours, and assuming a 85% annual load factor (see assumptions on power mix below). Other electrolysers (either alkaline or solid oxide) would have different CAPEX and efficiencies but a single technology was selected to minimise the number of routes modelled. Assumptions for current and future electrolyser capital costs, OPEX and energy efficiency were taken from an industry report¹².

Blue hydrogen production uses data for an SMR plant with a 90% CO₂ capture rate, and representative upstream fossil gas supply emissions. Other reformation technology e.g. ATR or ATR+GHR or Partial Oxidation would have different CAPEX, efficiencies and capture rates.

Sensitivity analysis allows the impact of alternative technology choices to be seen and the results of these are detailed in Appendix B.

CO₂ sources

Different sources for CO₂ have been considered. Biogenic (Route 1 and Route 7) and fossil (Route 2 and Route 8) point sources of CO₂ are assumed to arise from the combustion of forestry biomass residues and fossil natural gas respectively in power plants. CO₂ from both of these point sources is assumed to be captured from exhaust gases of these power plants and delivered to the fuel synthesis plant at a cost of €40/tCO₂.¹³ The CAPEX and OPEX for point source CO₂ capture and delivery are not modelled explicitly, but the GHG emissions calculations have taken into account the added electricity and heat requirements for CO₂ capture at these power plants (requiring more of the feedstock to be burnt). Note that no carbon tax has been applied in the analysis.

Five DAC options have been modelled based on high-temperature DAC data from Carbon Engineering, each with a different source of heat and power. These options are presented in Table 5.

¹² Hydrogen supply chain evidence base, Element Energy and Jacobs, Nov 2018, for the UK Department for Business, Energy & Industrial Strategy

¹³ Brynolf et al., 2018, "Electrofuels for the transport sector: A review of production costs"

Table 5: Heat and power sources for different DAC options

	DAC 1	DAC 2	DAC 3	DAC 4	DAC 5
Heat source	Natural gas	Green H ₂	Renewable electricity	Blue H ₂	Blue H ₂
Electricity source	Grid electricity	Renewable electricity	Renewable electricity	Grid electricity	Renewable electricity

The DAC energy sources chosen impact both the cost and GHG emissions as shown in Figure 15 and Figure 17. However, ‘base case’ scenarios for these DAC options were chosen to be paired with either green or blue hydrogen feedstocks for comparison with CO₂ from point sources, rather than present five DAC choices in every chart. These were:

- Natural gas for heat and grid electricity - this DAC 1 option (“Grid DAC” as in the Executive Summary) has been paired with routes utilising blue hydrogen (Route 9a);
- Green hydrogen for heat and renewable electricity - this DAC 2 (“Green DAC” as in the Executive Summary) option has been paired with chains using green hydrogen (Route 3b);

Since Carbon Engineering data is only available for fully commercialised plants (estimated to be achieved by 2050), scaling factors have been used to estimate 2020 and 2030 CAPEX and efficiencies. Sensitivity analysis is performed to assess the impact of changing these uncertain input energy requirements, which encompasses the range of input energy requirements seen by lower-temperature DAC systems as well.

FT liquids route

The RWGS reactor has a heating requirement and the FT plant has a minor electricity requirement which are treated in the following way:

- Natural gas for heat and grid electricity have been modelled as the inputs for routes utilising blue hydrogen.
- Green hydrogen for heat and renewable electricity have been modelled as the inputs for chains using green hydrogen.
- For the CO routes 13-15 grid electricity for power and natural gas for heat have been modelled in this study, although it is possible that more renewable sources could be used in the future which would affect both the cost and GHG emissions.

This is to ensure that the chains presented for comparison are ‘blue’ or ‘green’ throughout, from the origin of the hydrogen feedstock, including the power and heat requirements for DAC, as well as the power and heat requirements for the fuel synthesis processes.

Power mix

A blend of dedicated renewables such as solar and wind power may be able to achieve ~5,000 equivalent full load hours but the FT reactor and electrolyzers will achieve the lowest fuel production costs with ~7,500 full load hours or more. Therefore, even if there are dedicated renewables on site, this renewable electricity generation will likely have to be supplemented with grid electricity. To avoid the necessity of a direct renewables connection to the fuel synthesis plant with large battery storage, and to buy renewables across the grid for these additional hours, some form of contractual agreement (e.g. Power Purchase Agreement) and/or cancellation of guarantees of origin would likely

be required for the green hydrogen routes. This would need to be allowable under a policy mechanism – however, the RED II rules on renewable power additionality and any spatial or temporal correlation requirements are still being developed this year. For simplicity here, we have assumed that the supply to the electrolyser is fully renewable. A sensitivity has been run on the cost and GHG emissions impacts if different approach to power supplies is taken. However, by 2050, the NL grid is assumed to be fully decarbonised¹⁴, so the emissions difference between the approaches will disappear. Table 20 in Appendix B gives the key input assumptions.

GHG accounting

Regulation is still evolving with regards to synthetic fuels and a finalised GHG methodology for renewable fuels of non-biological origin and recycled carbon fuels are not fully defined under RED II yet, and only due to be finalised later in 2021. We have conducted our analysis on the latest understanding of likely EU policy decisions.

From a GHG accounting perspective, transport fuel policies in the EU (REDII) and in the UK (RTFO) do not include embodied emissions from the manufacturing, construction and decommissioning of renewable power plants, hydrogen production facilities or fuel production facilities within GHG emissions calculations. We have therefore not included these embodied emissions in our analysis.

3.2.2 Capacity ramp-up and feedstock modelling

The capacity ramp-up model is divided into two timeframes: the near term up to 2030 and the long term between 2030 and 2050. The modelling approach differs between the two stages, reflecting the degree of uncertainty that exists over the capacity build up.

In the short term, a ‘bottom-up’ approach is used, based on information on companies already active in the industry at European and global scale. The approach taken reflects the *technical ability* of the industry to scale-up, based on the current number of *technology developers*, *scale of existing and planned plants*, and plausible *build-rates* in this industry. This relies on both a supportive policy environment and technology developer success. This means that all companies currently working on synthetic kerosene production are assumed to continue to do so, and are assumed to license their technology once they get to a sufficient scale. Importantly, the framework of the model does not consider competition between the individual conversion routes or between different sectors.

In the long term to 2050, a ‘top-down’ approach is used. This allows the growth rate of the entire industry to be considered as opposed to the build-up capacity of individual technology developers. Starting in 2030, a constant growth rate is applied to the output volumes of individual routes. This allows the potential deployment of synthetic kerosene production technologies to be estimated taking their 2030 status into account, but still allows investigation of how they could plausibly develop in the future under a number of different scenarios.

The development of sustainable aviation fuels is heterogeneous and encompasses technologies at different stages of technical maturity. To be used in commercial aircraft, aviation fuels need to be ASTM certified. Today, only a limited number of sustainable aviation fuel (SAF) routes have this certification, others are either currently in the certification process or are at an even earlier stage.

¹⁴ In order to achieve a 95% overall GHG reduction by 2050: <https://www.government.nl/topics/climate-change/climate-policy>

However, the scale up assessment reflects the *potential production* of synthetic kerosene fuel and the same modelling approach is adopted regardless of whether a specific route is currently ASTM certified or not.

Some conversion routes use alcohol intermediates, ethanol (from steel mill off gas) and methanol (either from blue or green hydrogen), and these represent a potential pool of intermediate feedstock available for jet synthesis. For this assessment, the production of the intermediate alcohols was modelled separately from the jet fuel synthesis, reflecting the trends observed amongst technology developers, where alcohol production plants are operated separately from jet synthesis plants. This separation occurs because ethanol and methanol are versatile chemicals which have applications in many industries, not just fuel synthesis.

Therefore, in line with Section 3.1, the following simplified set of synthetic kerosene conversion routes are considered:

- **“Green FT”**: Green hydrogen + CO₂ routes to Fischer-Tropsch synthesis (routes 1-3).
- **“Green MtJ”**: Green hydrogen + CO₂ to methanol to jet synthesis (routes 4-6).
- **“CO to Jet”**: Fermentation of CO to ethanol to jet synthesis (route 13) or CO + Fischer-Tropsch synthesis (routes 14-15).

As explained above, routes involving blue hydrogen (routes 7-12) were not modelled in this ramp-up assessment, due to the lack of current activities. Further information about the modelling methodology and assumptions made can be found in Appendix A.

4 Results and analysis

4.1 Techno-economic modelling

4.1.1 Energy, cost and GHG emission results

In this section, we present the central case modelling outputs for route efficiency, levelised production cost and lifecycle GHG emissions. Further results when varying key parameters are explored in the sensitivity analysis in Appendix B. In this section, we first present the results for all the CO₂ to FT routes (1 – 3b and 7 – 9a) based around the central DAC case, before looking at the DAC options (routes 3a-3e and 9a-9e). We then present the results for the recycled fossil CO routes (13 – 15). Since very similar results were obtained for the methanol to jet routes as for the equivalent FT routes, for the sake of brevity in this section, the results for the methanol to jet routes (4 – 6 and 10 – 12) are provided in Appendix B.

Figure 13 compares the energy efficiencies of the green and blue FT routes today and forecast to 2030 and 2050. Lower heating value (LHV) efficiencies from starting renewable power or natural gas to synfuel products (a combination of similar synthetic fuels such as jet, diesel, gasoline and naphtha) generally lie within the range of 30 – 40%, although the DAC route is less efficient than routes using point CO₂ sources owing to the considerable electrical and heat energy required to capture CO₂ from the atmosphere. For an explanation of DAC1 and DAC2, please refer to Table 5. The acronym “PS” in the charts refers to Point Source capture of biogenic or fossil CO₂.

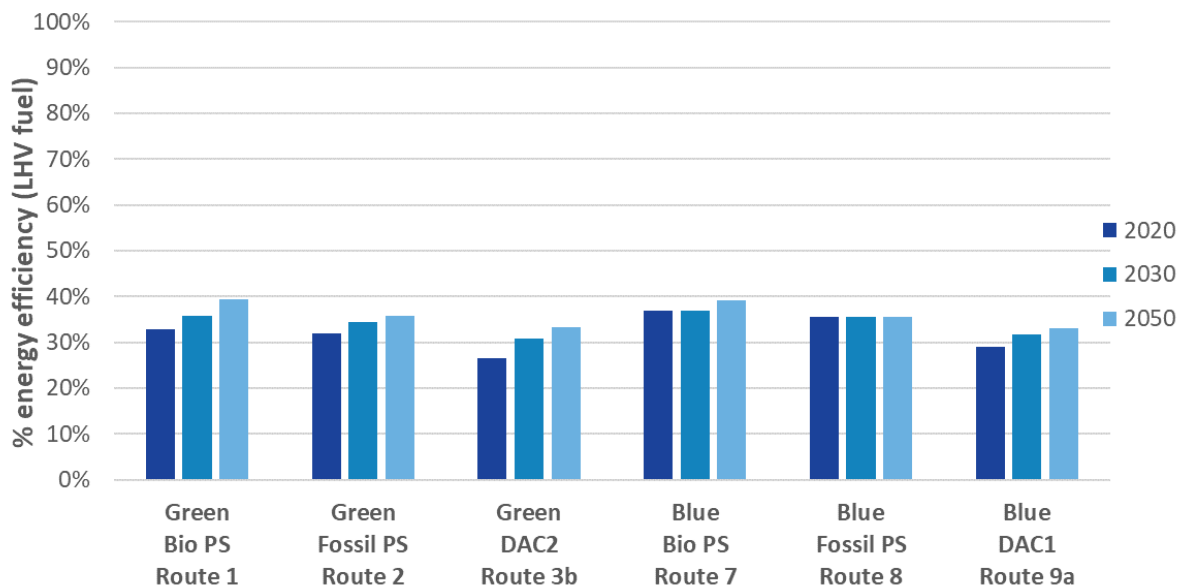

Figure 13: LHV efficiency of FT routes by year

In general, blue routes are slightly more efficient today than green routes, but green routes show greater improvements in efficiency over time meaning that by 2050 the green routes are as efficient as their blue counterparts. This mainly reflects the higher level of maturity of steam methane reforming compared with electrolysis. The small increase in efficiency of route 7 is explained by improvements in carbon capture technology while the improvements to route 9 can be largely explained by improvements to DAC. By contrast, electrolyser efficiency is expected to improve as

scales increase and further operating experience and process integration is achieved. Sensitivity tests showing the effects of improving electrolyser efficiency and reduced electrolyser CAPEX are shown in Appendix B. Most improvement is expected in the DAC routes (blue or green) given the relatively low TRL of DAC technology and the implied capacity for technological and process improvements which should be possible in the coming years.

Figure 14 provides a comparison of production costs across the FT routes over the target years and these have been broken down across the value chains to highlight the most important contributors to cost. For an explanation of DAC1 and DAC2, please refer to Table 5.

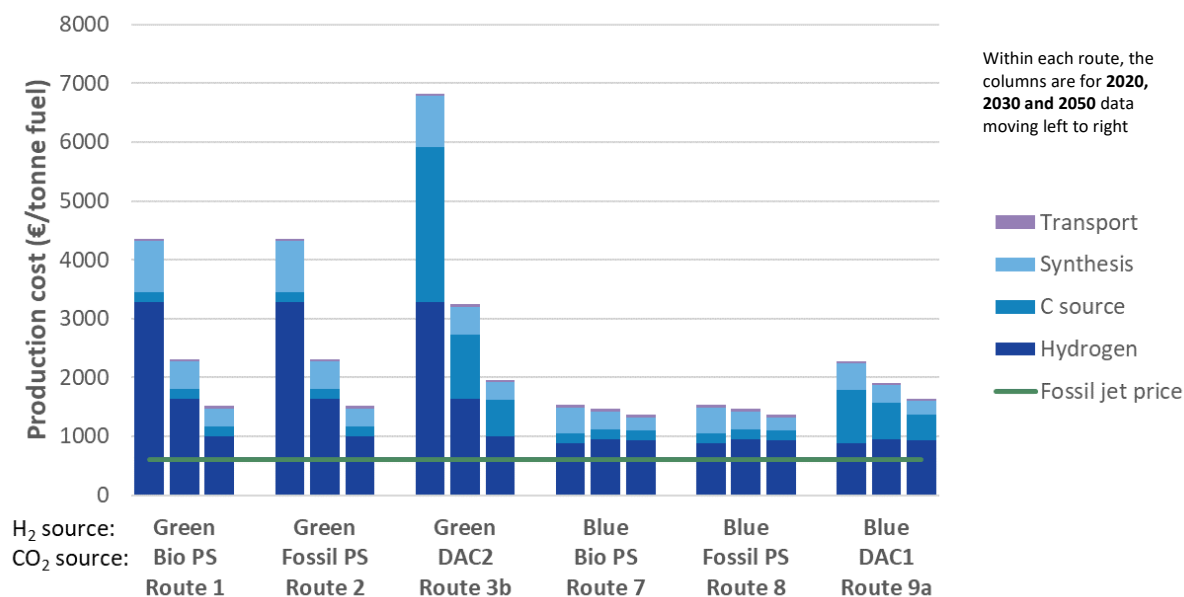

Figure 14: Production costs for FT routes by year

The values presented in Figure 14 show that the blue routes are initially lower cost than the equivalent green routes. In 2020 green routes are roughly 3x more costly than their blue counterparts, reflecting the much higher cost of renewable electricity relative to natural gas, even when the need to sequester the CO₂ emissions from SMR are taken into account. Falling renewable electricity costs and improving efficiencies mean that by 2050 green routes are likely to be only ~12 – 15% more expensive than blue routes.

A sensitivity test was performed to analyse the impact of switching from SMR to ATR and whilst this showed that the production costs are almost the same, ATR does offer some GHG improvements in 2030 and 2050 as this process has a higher CO₂ capture rate and higher efficiencies (Appendix B).

DAC routes are considerably more expensive than routes using point source CO₂, with the green route using DAC (route 3) being nearly 1.7x the cost of green point source routes in 2020 (although this differential falls to around 1.4x by 2050). Once again, DAC benefits from efficiency improvements, as well as decreases in renewable electricity and green hydrogen costs in the DAC2 option.

An indicative pre-COVID price of fossil jet of €600 per tonne is also shown in Figure 14 (noting that current fossil jet prices are lower than this level due to the pandemic). Both green and blue synthetic

routes are, and are expected to remain, significantly more expensive than fossil jet. By 2050 synthetic kerosene is likely to still be 2 – 4x the cost of fossil kerosene today, depending on the route considered. However, this does not account for any cost of carbon that may be attached to conventional kerosene (or synthetic kerosene routes) in the future.

Figure 15 shows the production costs using different sources of energy for heat and power when using high temperate DAC technology. The DAC technology modelled has a higher heat requirement than low temperature absorption based DAC, which may also have options for heat integration. However, HT DAC has been chosen here because it has more potential for rapid scale up given large-scale equipment. Whilst overall synthetic kerosene chains involving DAC may look comparatively less favourable today, there is a lot of potential for DAC cost improvements as the technology matures.

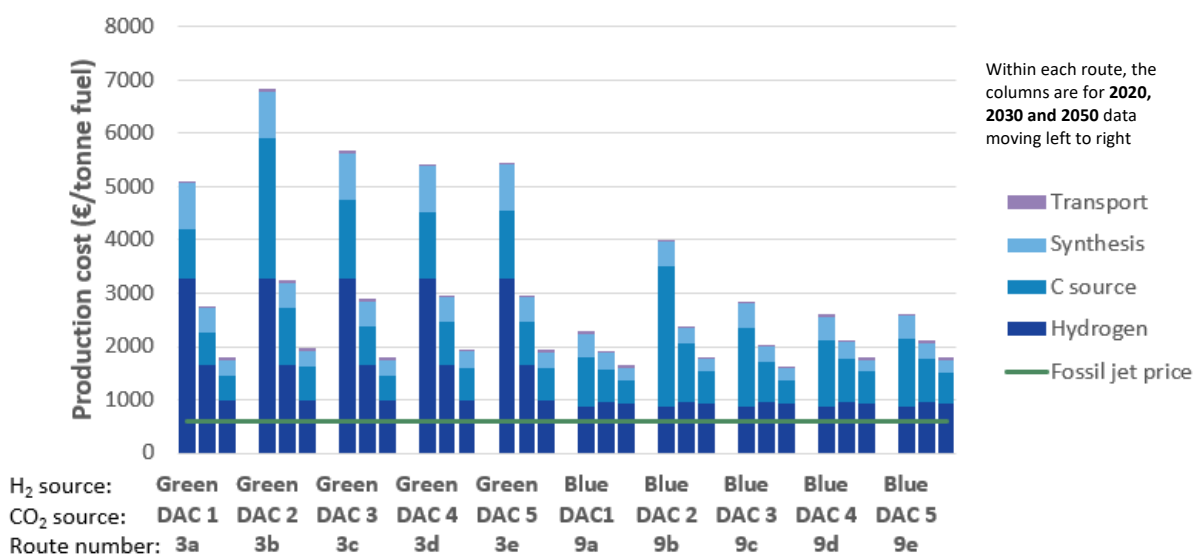

Figure 15: Comparison of production costs using different heat and electricity sources for DAC

Figure 16 presents the lifecycle GHG emissions associated with each of the FT routes, again broken down by year and by element of the value chain. As would be expected, green routes generally achieve very low GHG emissions with the biogenic and DAC routes each showing GHG emissions of ~5 gCO₂e/MJ of fuel. Emissions when a fossil point source of CO₂ is used are higher (~25 gCO₂e/MJ of fuel) reflecting the additional fossil gas required to capture the CO₂ at the power plant. The burning of this additional natural gas leads to both extra upstream and combustion emissions (because although the CO₂ that is released when the additional natural gas is burnt is mostly captured by the power plant equipment, this additional captured fossil CO₂ is also turned into jet fuel, ultimately releasing additional fossil carbon to atmosphere, and hence needs to be fully accounted for).

GHG emissions for the blue routes are considerably higher than green routes, primarily owing to the upstream emissions from fossil natural gas supplies¹⁵ and 10% of uncaptured CO₂ when producing blue hydrogen¹⁶. These two processes account for 62% and 38% of the emissions associated with blue hydrogen production respectively. In contrast to the green cases, the highest emissions are observed for DAC which is explained by the fact that in the blue routes, DAC is assumed to use

¹⁵ <https://ec.europa.eu/irc/en/publication/eur-scientific-and-technical-research-reports/jec-well-tank-report-v5>
GMCG1 pathway, up to point of compression and dispensing

¹⁶ IEA GHG Technical Report 2017-02: Techno-Economic Evaluation of SMR Based Standalone (Merchant) Hydrogen Plant with CCS. Page 4.

natural gas and grid electricity as its energy sources (unlike the green routes). For explanation of ‘DAC1’ and ‘DAC2’, please refer to Table 5.

Note that the synthesis steps also require heat input for the RWGS reactor. In the blue routes, this is provided by natural gas so there are synthesis emissions, but in the green routes this is provided by green H₂ so the synthesis step has minimal GHG emissions.

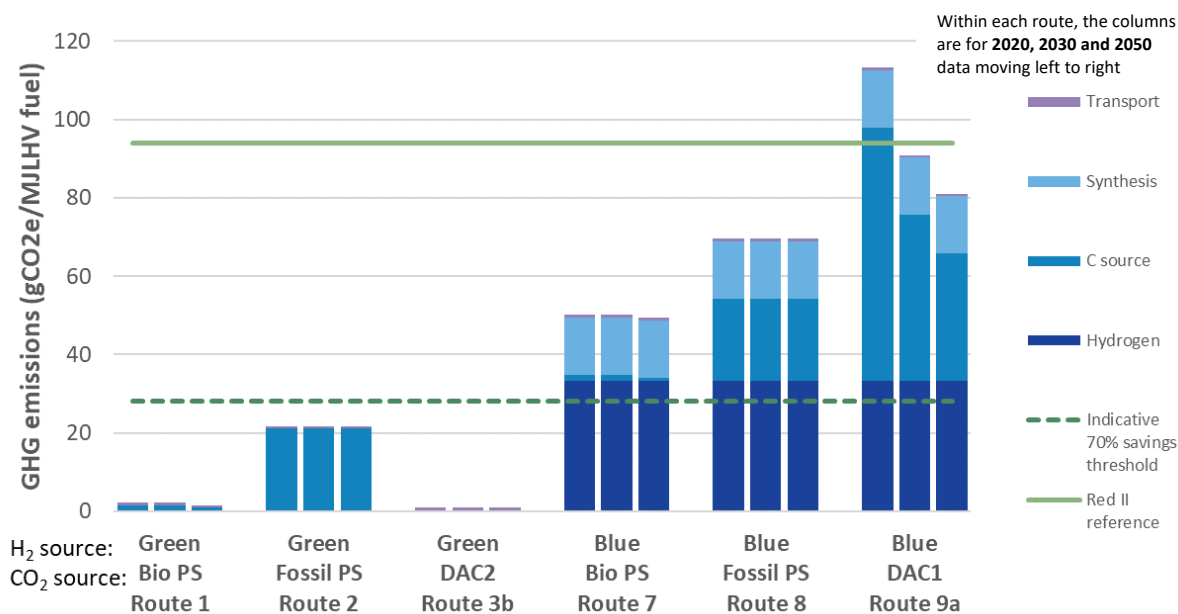

Figure 16: Lifecycle GHG emissions by FT route and year

RED II specifies a fossil transport counterfactual of 94 gCO₂e/MJ. Given the EU context, this level has been used in this analysis, rather than the value of 89 gCO₂e/MJ used by CORSIA. RED II has already set a minimum GHG saving threshold of 70% for renewable fuels of non-biological origin, which would apply to the green routes, requiring <28.5 gCO₂e/MJ SAF. However, a minimum GHG saving threshold or GHG methodology has not yet been finalised for ‘recycled carbon fuel’ routes, which would likely impact many/most of the blue H₂ + CO₂ routes (route 7-12) and fossil CO routes (routes 13-15). These will be set at EU-level later in 2021. There is uncertainty over whether blue hydrogen with DAC (route 9) would count as a ‘recycled carbon fuel’.

All routes, except the blue H₂ + DAC route 9, have GHG emissions below the RED II fossil transport counterfactual in 2020. However, none of the blue routes can achieve above a 55% GHG saving in any year, while all the green routes have GHG savings above the 70% saving threshold in all years. Note that the blue hydrogen production emissions alone within routes 7-12 exceed 28.5 gCO₂e/MJ SAF level, reflecting the impact of the upstream natural gas emissions, reforming efficiency losses and the 10% of fossil CO₂ that is assumed not to be captured in reforming, therefore highlighting the fundamental emissions challenge facing routes 7-12. Depending on the level of the RED II threshold for recycled carbon fuels, all blue routes (routes 7-12) might be ruled ineligible under RED II.

Furthermore, all the point source CO₂ routes (routes 1-2, 4-5, 7-8, 10-11) are assuming that the counterfactual fate of the CO₂, if not converted into fuels, would be release to atmosphere and not sequestered. Whilst potential RED II changes during 2021 are unlikely to address different counterfactuals for CO₂ feedstocks (rule changes for ‘recycled carbon fuels’ are only likely to focus on

energy-containing feedstocks such as waste fossil CO gases), long-term decarbonisation of point sources and the roll-out of CCS could lead to this atmospheric release assumption being challenged. If the counterfactual were CCS, and EU rules in a subsequent iteration of RED II (or post 2030) were changed, then all point source CO₂ routes to fuels would have extremely high GHG emissions (likely higher emissions than conventional fossil jet, due to release of feedstock CO₂ to atmosphere rather than sequestration).

DAC routes would however likely still have the same GHG emissions as presented in this section, as the building of DAC plants for fuels production is discretionary and the counterfactual that CO₂ stays in the atmosphere is unlikely to change. Figure 17 shows the associated GHG emissions for the different DAC options (as described in Table 5). DAC1 is unable to meet the 70% saving threshold for the green route in all years, given the use of natural gas heating and grid power. Green hydrogen routes utilising DAC will therefore likely be forced to not use the DAC1 configuration option if they wish to be compliant with RED II, and will have to focus on DAC 2-5 options instead. DAC 4-5 have emissions closer to the threshold, due to the use of blue H₂ in DAC heating.

DAC1 is also a worst case for the blue routes, and would appear to likely be ineligible under RED II regardless of where the threshold is set for recycled carbon fuels. None of the other DAC options can achieve more than a 55% GHG saving when using blue hydrogen.

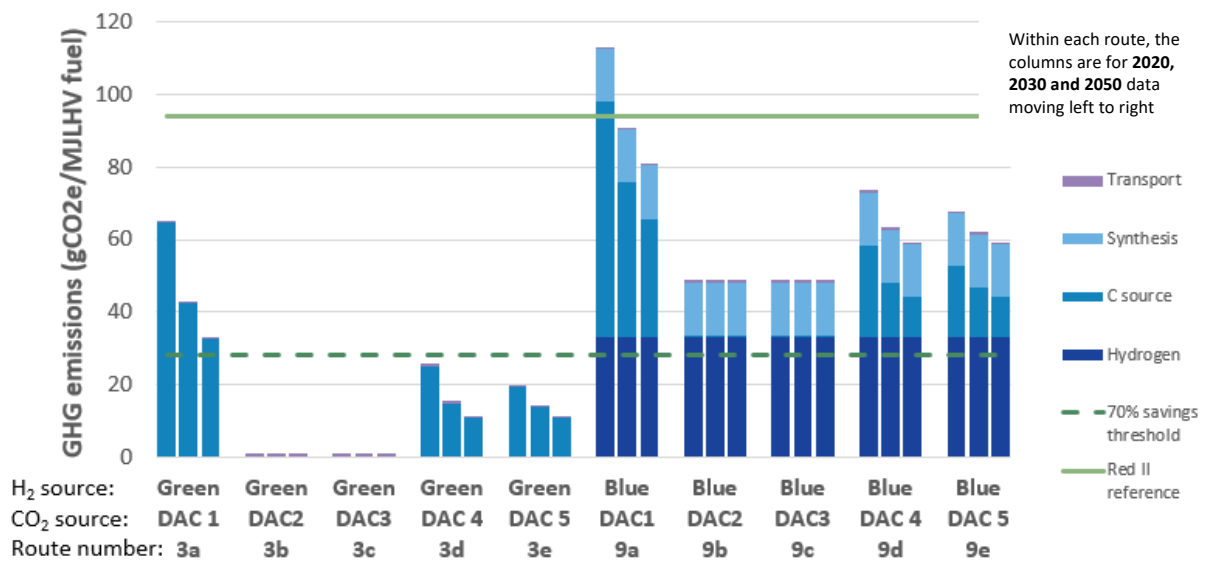

Figure 17: Comparison of GHG emissions using different heat and electricity sources for DAC

The results for the recycled fossil CO routes are presented in the following charts. They are modelled using as similar an approach as possible to the FT routes above, with as many common assumptions used across the datasets as possible. However, they are not completely comparable with the CO₂ routes or each other due to inherent differences in the plant configurations. For example, the project developers for both CO routes envisage much larger scale plants than those modelled in the green or blue FT routes above (by 2050, ~17x the size for the CO + FT routes and ~3x the size for the CO fermentation route). These CO routes therefore benefit from economies of scale, and a significant proportion the CAPEX for these plants are based on retrofitting equipment to existing facilities rather

than building new greenfield plants. Furthermore, the developer data for routes 14-15 did not include a full mass balance, and assumptions on FT yields¹⁷ and CO₂ capture rates appear to be at the most optimistic end of feasible ranges, compared to more modest assumptions taken in our analysis of routes 1-12.

These recycled fossil CO routes also utilise a degree of heat integration and recycling of materials which has not been included for routes with CO₂ as a feedstock. For the recycled fossil CO routes, grid electricity has been modelled wherever electricity is used and natural gas has been used wherever a heat source is used. However these routes are not necessarily tied to these energy sources and so it is possible that green hydrogen and renewable electricity could also be used. For the fossil CO + FT routes (routes 14-15), only data for 2030 was available from the project developer, as their assumption was that by 2050 steel making in the EU will have largely decarbonised (switching to using hydrogen, electricity, or biomass methods) and so the steel mill waste fossil CO gas stream is unlikely to be available. There also may be potential for input CO₂ sources (with water-gas shift) to replace steel mill fossil CO over time, i.e. FT synthesis plants changing their carbon source, but this has not been explicitly modelled in this study.

The recycled fossil CO route energy efficiencies are presented in Figure 18 which points to higher levels of efficiency than those achieved for routes 1-12 using CO₂ as a feedstock. This is explained by the fact that RWGS is no longer required, and the CO feedstock contains considerable energy already (unlike CO₂ which contains no energy). For route 15, the input natural gas used to generate blue hydrogen is included in the overall pathway values, for comparability with routes 1-12.

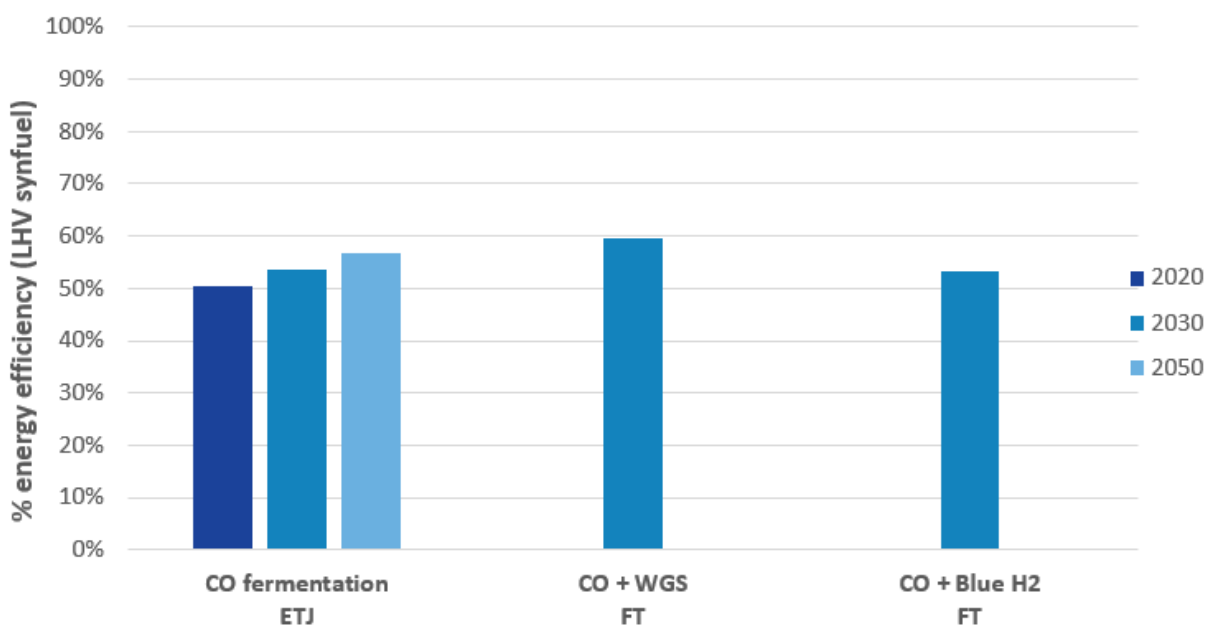

Figure 18: LHV efficiency of recycled fossil CO routes (13 - 15) by year

¹⁷ Becker et al. (2012) "Production of Fischer–Tropsch liquid fuels from high temperature solid oxide co-electrolysis units", <https://www.sciencedirect.com/science/article/abs/pii/S0360544212006792> Becker et al. state that FT reactor single-pass conversion rates for CO typically range from 60-90%, with higher rates having lower selectivity to longer hydrocarbons. 80% is chosen as a baseline performance value in their study, and matches the assumption taken for routes 1-12 in this study, whereas data for routes 14-15 are at the top of this range. However, routes 14-15 are assuming much larger-scale FT than in routes 1-12, and therefore recycle loops through the FT reactor may be viable, allowing higher conversion rates to be achieved than in single-pass configurations.

Figure 19 presents the calculated costs for the CO fermentation + ethanol to jet route. Costs fall considerably between 2020 and 2050 owing mainly to reducing capital expenditure resulting from e.g. economies of scale and falling O&M costs/learning, but still remain above today's fossil jet prices by 2050. The microbial protein co-product made during fermentation could be an additional revenue stream, as it could be valued at up to €1340/tonne of protein (equivalent to €228 per tonne jet fuel), but this has not been explicitly factored into these production costs as the market for this co-product is still uncertain.

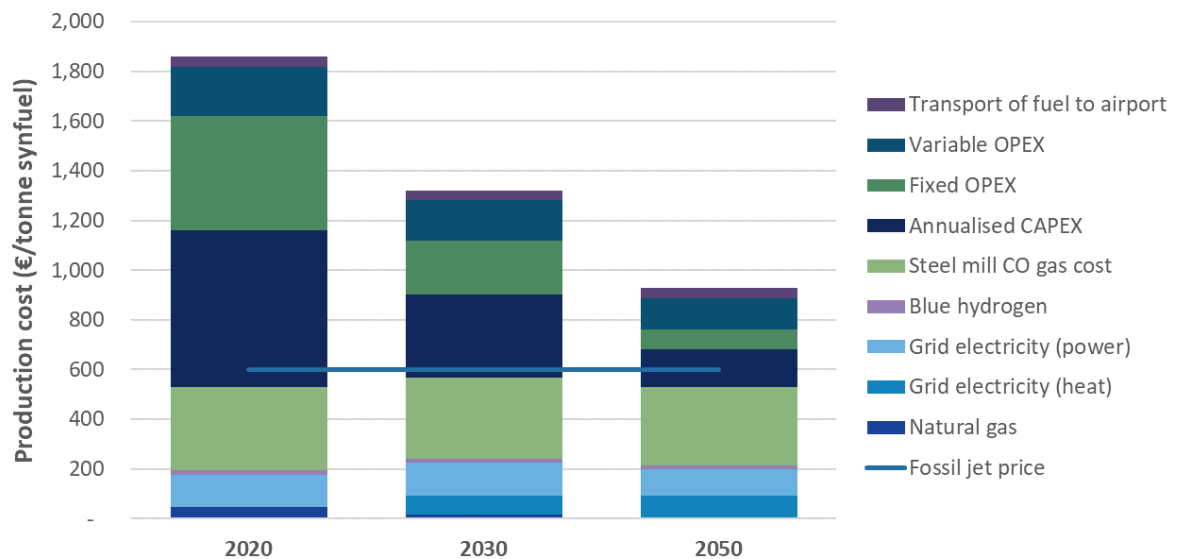

Figure 19: Production costs for the CO fermentation + ETJ (Route 13)

The costs of the CO + FT routes are shown in Figure 20. The €/tonne cost of steel mill CO gases been taken to be equivalent to that used in route 13 for consistency. The WGS reaction produces a substantial amount of by-product CO₂ which the project developer plans to capture (at a very high % rate) and sequester, and the costs of this have been included in Figure 20 and in the GHG emissions saving shown in Figure 24. The downstream cost of sequestration used here is consistent with that used for sequestering CO₂ produced from the SMR plant during the synthesis of blue hydrogen. All the costs associated with the production of the blue hydrogen have been encompassed within the single 'blue hydrogen' part of the stack chart in the 'CO + Blue H₂ FT' column (route 15), and include costs for natural gas, annualised CAPEX, fixed and variable OPEX and the downstream costs of sequestering 90% of the CO₂ produced – hence why the downstream transport and storage of CO₂ is not split out for route 15, given blue hydrogen is purchased by the FT plant.

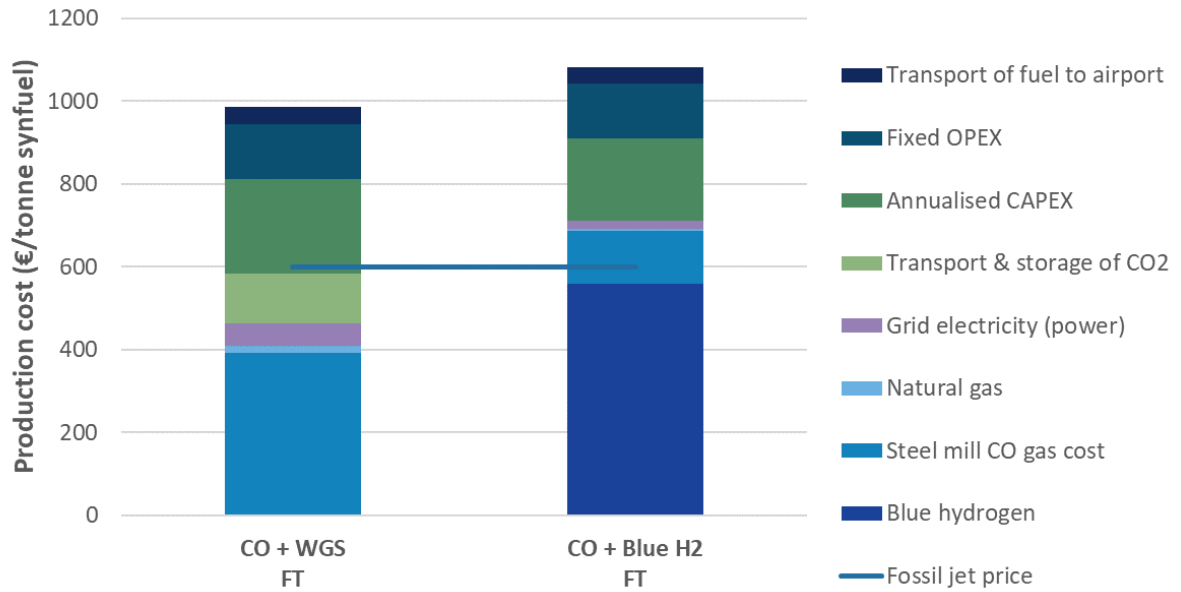
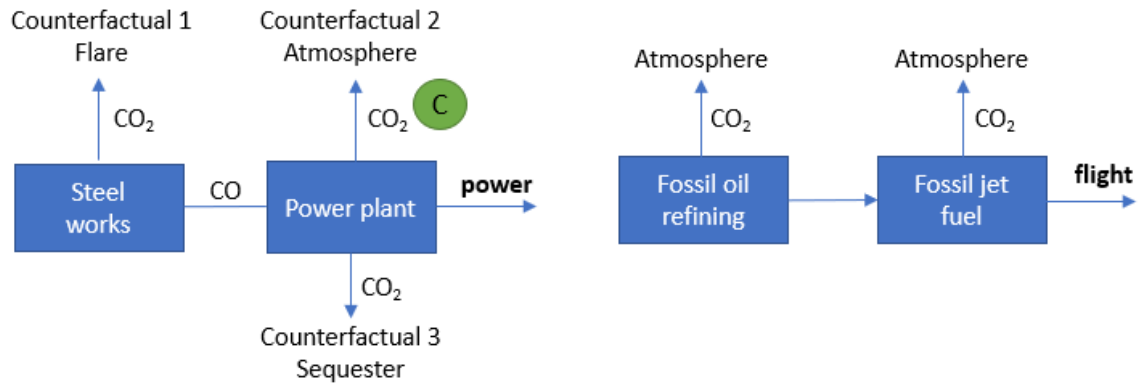

Figure 20: Comparative production costs for CO + FT in 2030 (Routes 14 & 15)

Direct GHG emissions will be produced during the production of synthetic kerosene via the recycled fossil CO routes (13-15). However, following a recycled carbon fuel methodology proposed by JRC, the relative importance of these should be considered in the context of a counterfactual, i.e. what would have happened to the steel mill gases if they had not been used to produce synthetic fuels.

Counterfactual use of steel mill gas for power generation, fossil jet used in aviation



Steel mill gas diverted to synthetic kerosene production, additional grid power generation required

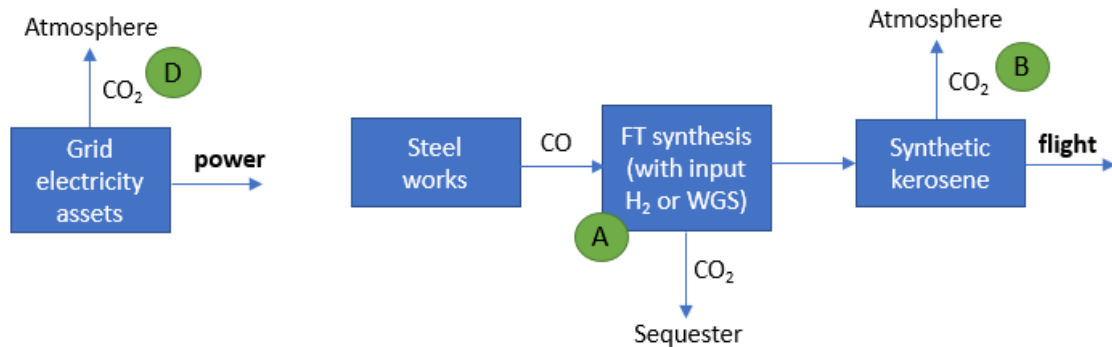

Figure 21: Illustration of CO counterfactual cases, and synthetic kerosene production

Three counterfactual options are shown in Figure 21 and described below:

1. Flaring of the steel mill CO gas – this case has not been shown on separate charts, but the net GHG emissions of the synthetic kerosene produced would just include the direct emissions from the processes required to generate the fuel, as there are no displaced emissions.
2. Steel mill CO gases are combusted to produce electricity for the grid, using 35% efficiency at a power plant with unabated emissions (Figure 22 and Figure 24).
3. Steel mill CO gases are combusted to produce electricity for the grid using a 25% efficiency at a power plant with abated emissions (90% carbon capture rate – the lower efficiency taking into account the additional energy required for CCS). (Figure 23 and Figure 25).

For counterfactuals 2 and 3, more grid electricity generation is required to replace the lost power plant generation when steel mill CO gases are diverted from electricity to synthetic kerosene production. Following a recycled carbon fuel methodology proposed by JRC, these additional grid emissions are displaced emissions that should also be accounted for in the synthetic kerosene GHG emissions calculations (because they were previously a GHG saving made when generating power).

In the unabated case 2, the carbon dioxide that would have been released to the atmosphere upon steel mill CO gas combustion for electricity generation at the steel mill's power unit is the same carbon dioxide that is released to atmosphere upon combustion of the synthetic kerosene plus any CO₂ released in production of the synthetic kerosene. Therefore, as long as the carbon emissions liability remains with the steel manufacturer, this carbon can be utilised in electricity generation or synthetic kerosene, without having to account for it upon combustion in either electricity generation or jet engines. However, if the steel mill were to claim a reduction in its carbon liability (i.e. the counterfactual becomes more abated / case 3), this benefit would shrink or disappear. Or if the steel mill were to sell captured CO₂ after power generation for making fuels via e.g. route 2, this benefit would also disappear (as geological sequestration of the CO₂ is not occurring).

Following the RED II methodology as applied to biofuels, and assuming similar rules will apply to the direct processing emissions of recycled carbon fuels, the microbial protein generated in route 13 as a co-product has a LHV energy content, and so 8% of the process emissions have been allocated to this co-product in proportion to its LHV energy content vs the overall energy content of all products and co-products (including synthetic fuels). This has slightly reduced some of the emissions shown in both Figure 22 and Figure 23.

Figure 22 shows the GHG emissions for the CO fermentation + ETJ (route 13) where the counterfactual is an unabated power plant at 35% efficiency. Note that in this unabated counterfactual scenario, the sum of the fuel and processing CO₂ emissions equals the power plant CO₂ emissions (and therefore cancel out). The direct emissions from inputs to synthetic kerosene production are shown without dotted outlines.

Figure 22 demonstrates the approach used to calculate the net GHG emissions for the recycled fossil CO-based synthetic kerosene routes in this study, using the following formula (with terms A to D corresponding to the green labels in Figure 21):

CO-based synthetic kerosene net GHG emissions (red dot)
 = A. Emissions from inputs to synfuel processing & distribution (left-hand bars without dotted lines)
 + B. CO₂ released in synfuel processing & combustion (left-hand orange/yellow bars with dotted lines)

– C. CO₂ released in the counterfactual power generation use (right-hand light grey bar above x-axis)
+ D. Additional grid emissions from displacement of counterfactual power generation (right-hand dark grey bar below x-axis – these are shown as a negative value on the charts, since these are effectively a benefit of the counterfactual scenario emissions, and therefore are an added impact of synthetic kerosene production).

As demonstrated in Figure 22, the only element not covered is conventional fossil jet production and use, as this is what the synthetic kerosene net GHG emissions can now be compared against.

Based on the chosen Netherlands grid factor, the GHG savings today if only including processing inputs would only be around 55%, and inclusion of displaced emissions today (were this change to RED II decided and already in force) would lead to net emissions above the REDII fossil benchmark. However, the net GHG emissions for synthetic kerosene are expected to fall dramatically over time, mainly as a result of electricity grid decarbonisation over time (reducing the direct process emissions and reducing the displaced feedstock emissions associated with diverting CO from electricity to synthetic kerosene production), plus switching from natural gas to electricity for steam production. By 2030, both direct and displaced emissions will have fallen significantly, leading to net emissions near 70%. This scenario is presuming the unabated counterfactual is still the correct counterfactual to take in the calculations over time.

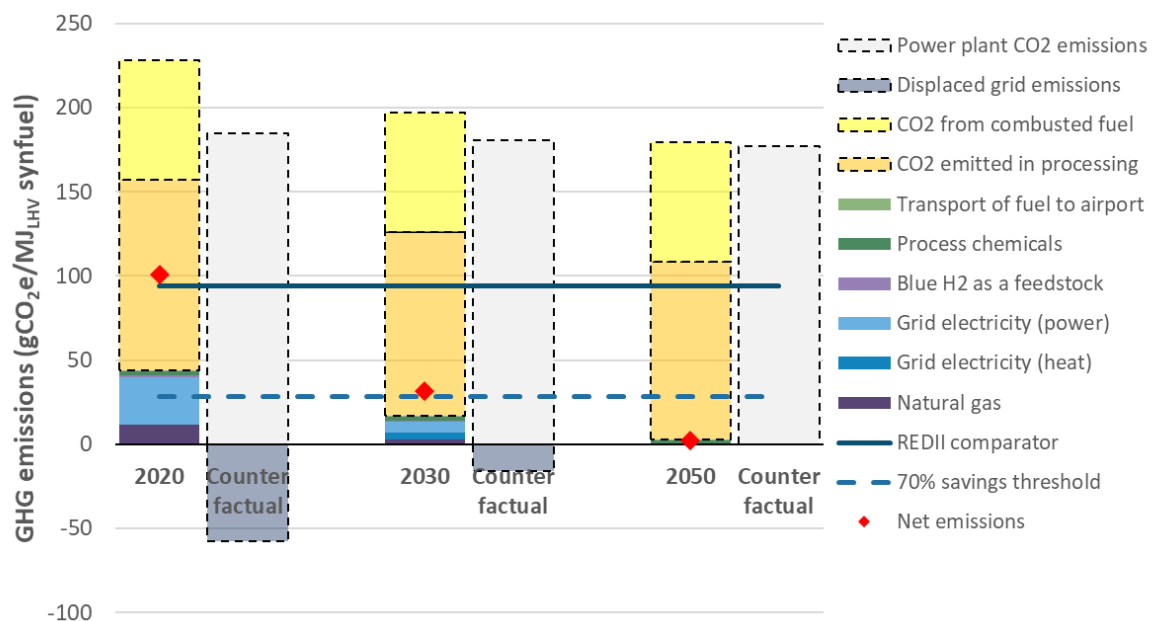

Figure 22: GHG emissions for the CO fermentation + ETJ (Route 13) where the counterfactual is steel mill CO gas use in an unabated power plant at 35% efficiency

Figure 23 shows the GHG emissions for the CO fermentation + ETJ (route 13) where the counterfactual is an abated power plant at 25% efficiency and 90% CCS. In this abated counterfactual scenario, the power plant CO₂ emissions are significantly reduced, and the displaced grid emissions are slightly reduced (due to lower power generation efficiency). The emissions from synthetic kerosene inputs, fuel combustion emissions and processing emissions remain unchanged from the previous counterfactual scenario.

Net GHG emissions for synthetic kerosene are significantly above the RED II fossil transport benchmark in all years, due to the release of fossil CO₂ to atmosphere compared to geological sequestration via power generation. There is a small saving from avoiding the 10% uncaptured CO₂ at the power plant being released to atmosphere, but when making jet fuel all the carbon in the feedstock is released to atmosphere (whether vented in the process, or in jet fuel combustion). An abated counterfactual will therefore not lead to compliance with RED II, regardless of the threshold level – but power plants will increasingly become abated over time, i.e. this counterfactual will become more relevant to 2050.

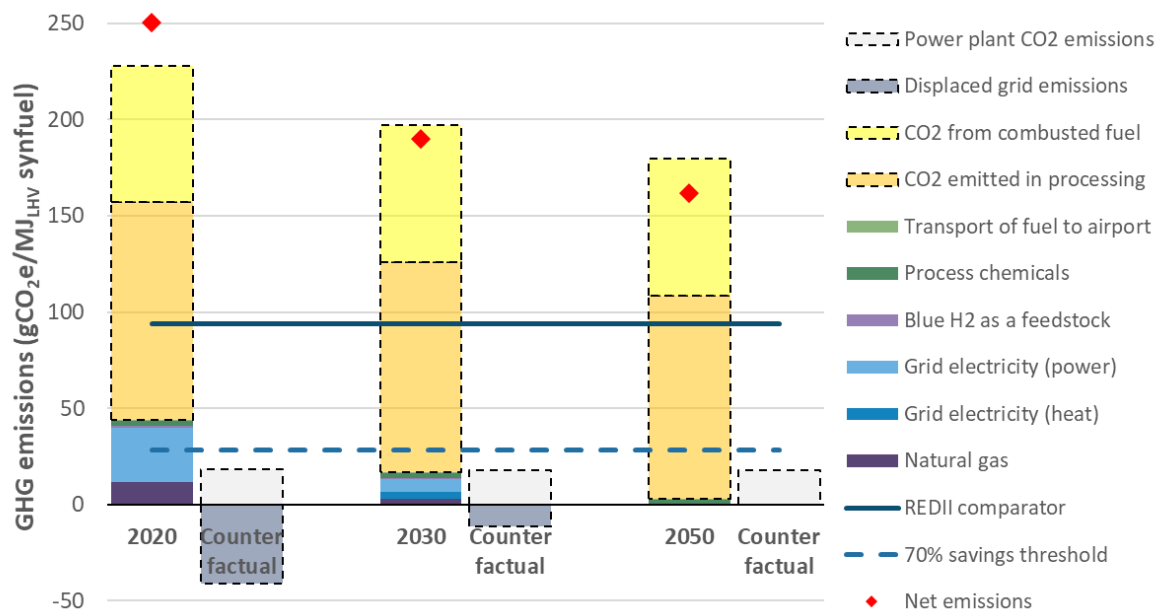

Figure 23: GHG emissions for the CO fermentation + ETJ (Route 13) where the counterfactual is steel mill CO gas use in an abated power plant at 25% efficiency and 90% capture rate

Figure 24 and Figure 25 present the lifecycle GHG emissions for the CO + FT routes (note only data for 2030 was provided for these routes). Figure 24 presents the emissions in a scenario where an unabated power plant is the counterfactual (most likely to be valid in the near- to mid-term), and

Focusing just on the processing input emissions, Figure 24 shows that both CO + FT routes (14 and 15) are likely to achieve GHG savings of above 70% in 2030. There are also large fuel combustion emissions, and small process CO₂ emissions (as the large majority of CO₂ released in processing is captured and sequestered). However, the counterfactual power plant has high emissions to atmosphere, particularly in the route 14 counterfactual, where these emissions are especially high due to the high CO input per tonne of jet production in route 14 (due to WGS). These power plant CO₂ emissions either offset the fuel and process CO₂ emissions in route 15, or significantly more than offset them in route 14, leading to a net negative GHG emissions for route 14.

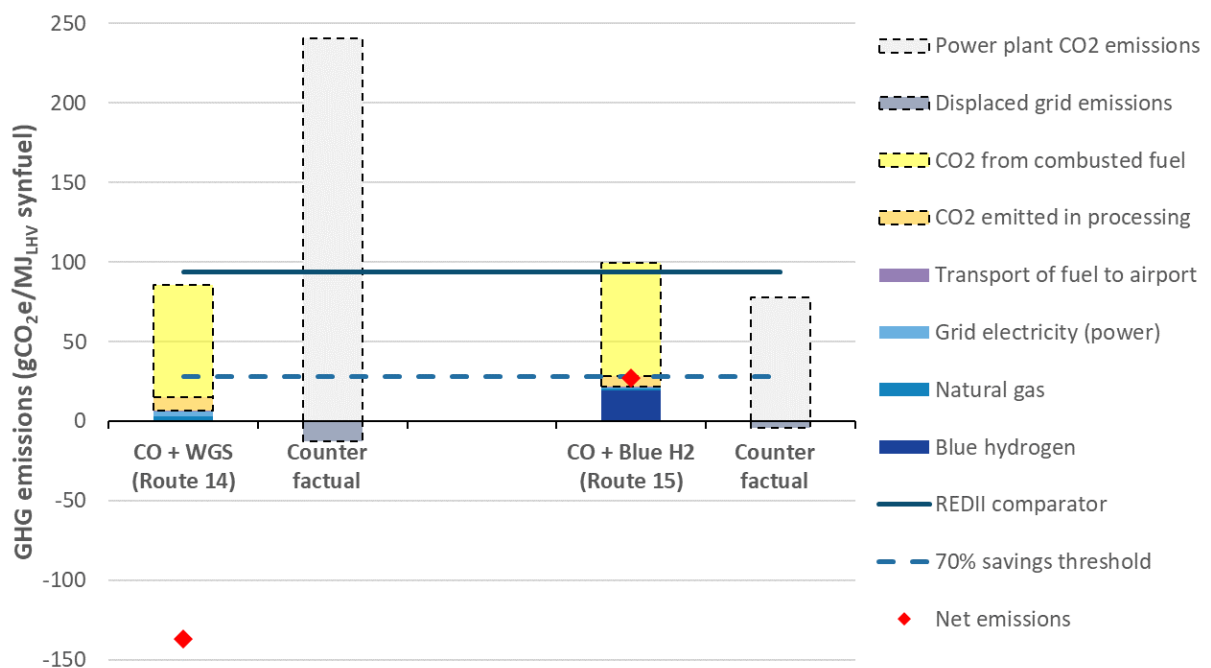

Figure 24: Comparative lifecycle GHG emissions for CO + FT routes in 2030 (14 and 15) where the counterfactual is steel mill CO gas use in an unabated power plant at 35% efficiency

Figure 25 illustrates the emissions if an abated power plant with a 90% CO₂ capture rate is the counterfactual (most likely to be valid in the mid- to long-term as CCS is rolled out). The emissions from synthetic kerosene inputs, fuel combustion emissions and processing CO₂ emissions remain unchanged between Figure 24 and Figure 25. However, in this abated counterfactual scenario, the power plant CO₂ emissions are significantly reduced, and the displaced grid emissions are slightly reduced (due to lower power generation efficiency).

Net GHG emissions for synthetic kerosene are close to the RED II fossil transport benchmark in 2030 (i.e. GHG savings are small or non-existent), due to the release of fossil CO₂ to atmosphere compared to geological sequestration via power generation. Power plants will increasingly become abated over time, i.e. this counterfactual will become increasingly relevant in the period 2030 to 2050. The correct counterfactual to use and how it might need to evolve over time is a policy decision, and for those recycled carbon fuels in scope of REDII, this is likely to be determined by REDII delegated act during 2021. A breakdown of energy inputs and a sensitivity analysis is provided in Appendix B.

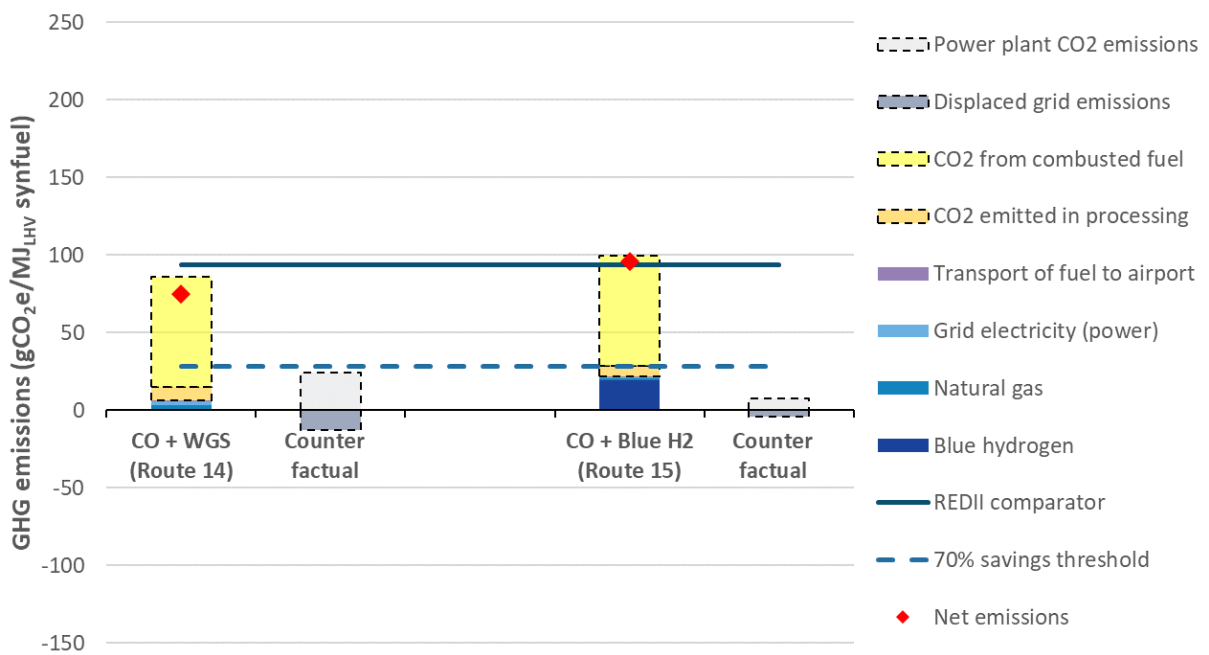

Figure 25: Comparative lifecycle GHG emissions for CO + FT routes in 2030 (14 and 15) where the counterfactual is steel mill CO gas use in an abated power plant at 25% efficiency with a 90% capture rate

4.1.2 GHG abatement cost results

Figure 26 presents the cost of GHG abatement for each of the FT routes. These abatement costs are generally lower for blue routes than for green routes today, suggesting that the lower costs of blue routes outweighs their significantly higher GHG emissions – but this situation is reversed by 2050 as green routes costs fall. There is considerable overlap between green and blue abatement costs in 2030. Note that for route 9, GHG emissions are higher than for fossil kerosene in 2020 and 2030 so abatement costs have been omitted, and route 9 abatement costs in 2050 remain high, due to the small GHG savings.

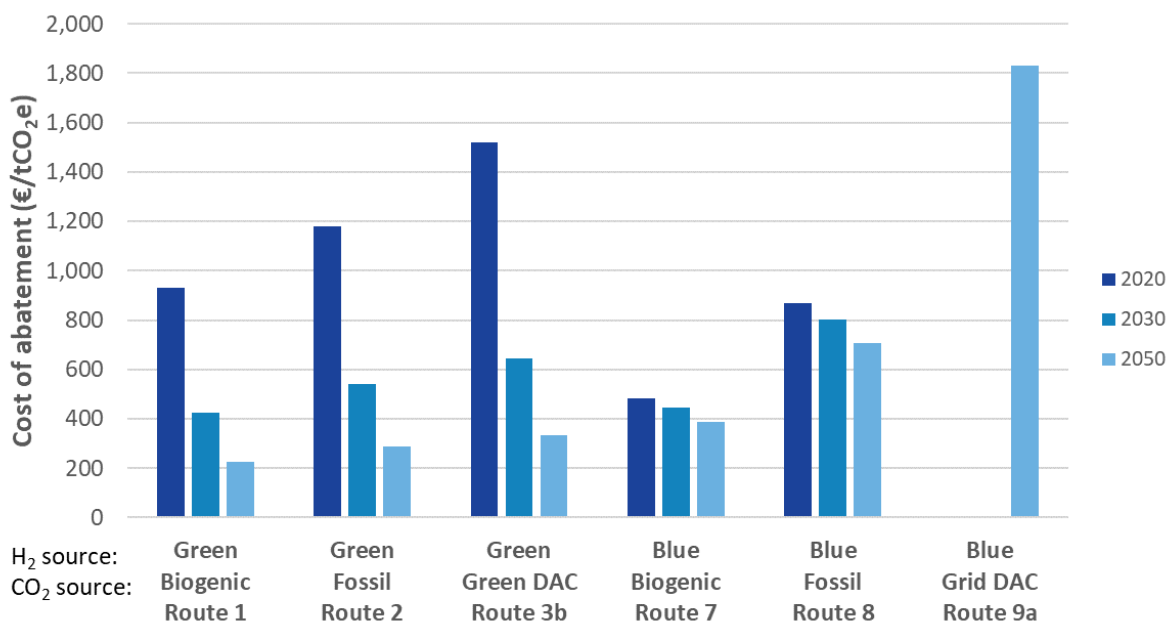

Figure 26: GHG abatement costs for FT routes

The abatement cost levels achieved in 2050 for the most attractive routes are similar to the levels anticipated for biofuels (see Section 4.2.7) and in the same range as biomass power production with CCS. However, current abatement costs are considerably higher than current carbon prices or policy abatement costs in many other sectors of the economy.

Green and blue routes using DAC also have abatement costs that are higher than just using DAC with CCS, suggesting that from a policy perspective, other considerations such as airline fuel security or customer pressure, CCS constraints or aviation non-CO₂ effect benefits from using cleaner burning SAF may have to be considered in addition to just the GHG abatement cost if DAC is to be used in jet fuel production and not just CCS.

Figure 27 presents the GHG abatement costs for methanol routes and reflects the fact that these have very similar performance from a cost and GHG perspective to the FT routes. Note that for route 12, emissions in 2020 and 2030 are higher than for fossil kerosene so abatement costs have been omitted, and route 12 abatement costs in 2050 remain high at ~€3750/tCO₂e, well above the y-axis range given.

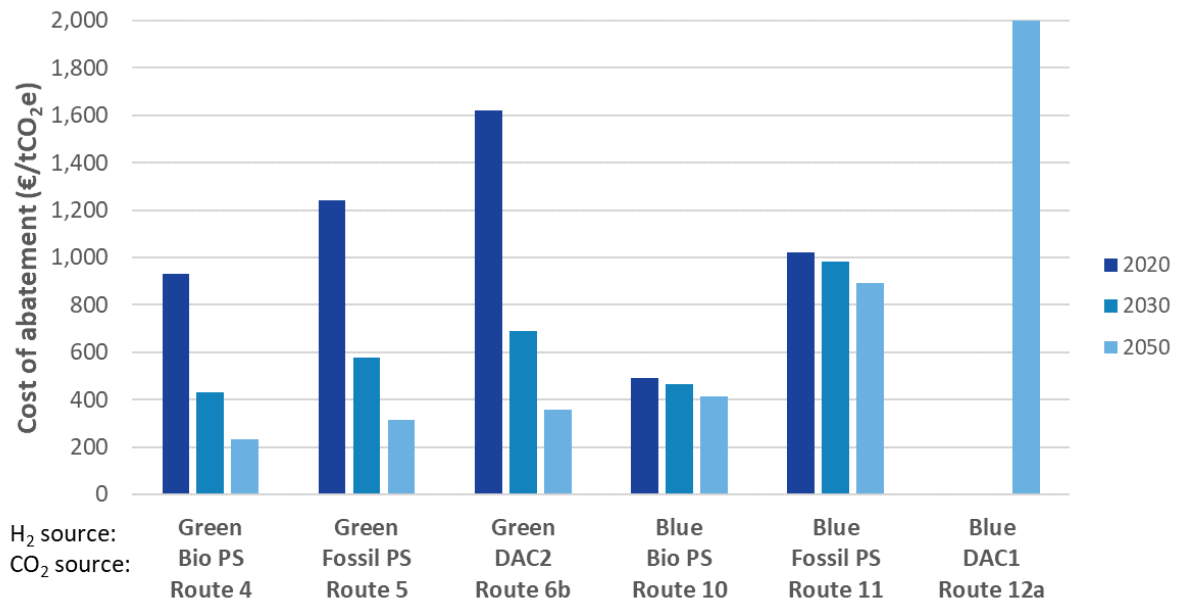

Figure 27: GHG abatement costs for methanol routes

Figure 28 presents the cost of GHG abatement for each of the CO based routes in 2030, assuming an unabated counterfactual. The fermentation route could achieve lower abatement costs compared with the CO₂ routes in 2030. Routes 14 and 15 show even lower GHG abatement costs in 2030, particularly for CO + WGS, due to the large amount of CO₂ captured and sequestered compared to the unabated power generation counterfactual. However, if an abated counterfactual were used, GHG emissions for routes 13 and 15 in 2030 are higher than fossil kerosene (so there is no abatement), and route 14 has an increased abatement cost of ~€450/tCO₂e, due to the significant fall in GHG savings.

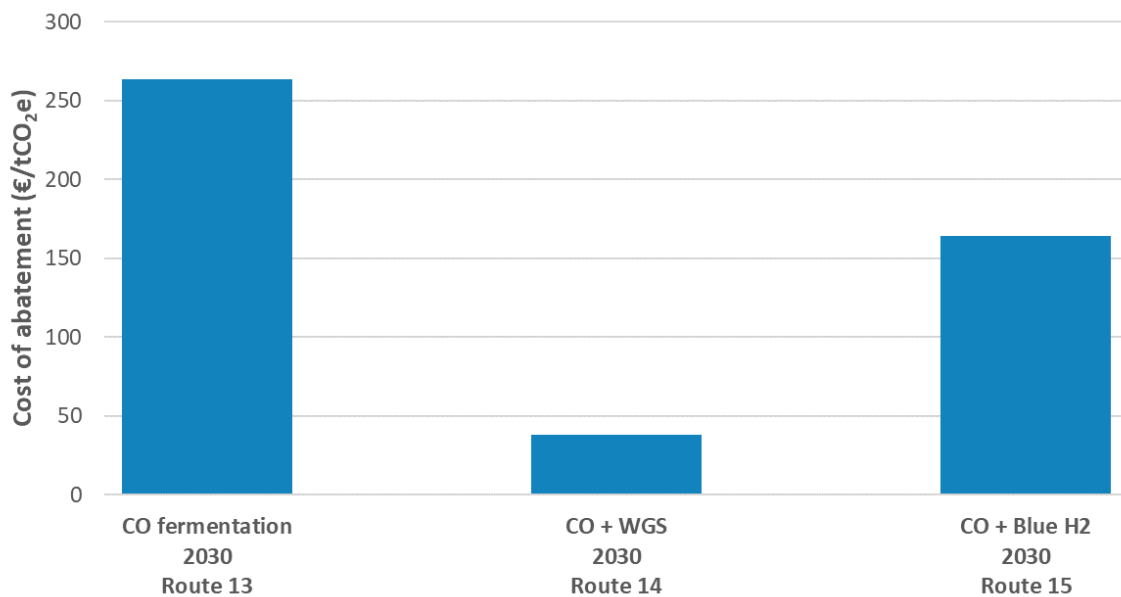

Figure 28: GHG abatement costs for CO routes (considering an unabated counterfactual)

4.1.3 Potential impact on ticket prices

In this section the implied cost to passengers associated with different fuel routes is estimated based on the initial assumption that airlines would pass on the full additional fuel cost to passengers on flights which refuel with a synthetic kerosene blend. The cost ranges for each set of routes is set out in Table 6, using 2030 data from this study.

Table 6: Assumed kerosene costs in €/tonne in 2030

Assumption	Value
Cost of conventional fossil kerosene	600
Green synthetic kerosene cost (high)	3200
Green synthetic kerosene cost (low)	2300
Blue synthetic kerosene cost (high)	1900
Blue synthetic kerosene cost (low)	1500
CO based synthetic kerosene cost (high)	1300
CO based synthetic kerosene cost (low)	1000

Based on the estimated additional fuel cost per tonne compared with conventional fossil kerosene, and two illustrative flights¹⁸, an estimation was made of the additional cost of fuel per flight:

- Short-haul flight from Amsterdam to Rome on Boeing 737: flight distance 1,300 km, 160 passengers, 5 tonnes fuel burnt
- Long-haul flight from Amsterdam to New York on Boeing 777: flight distance 5,800 km, 310 passengers, 47 tonnes fuel burnt

Assuming that the total added fuel cost for the flight is passed on equally to all passengers, the additional cost per passenger per flight for green synthetic kerosene routes is illustrated in Figure 29. Bars illustrate the average synthetic kerosene costs, based on the average of low and high costs, whereas the uncertainty intervals refer to the high and low cost scenarios.

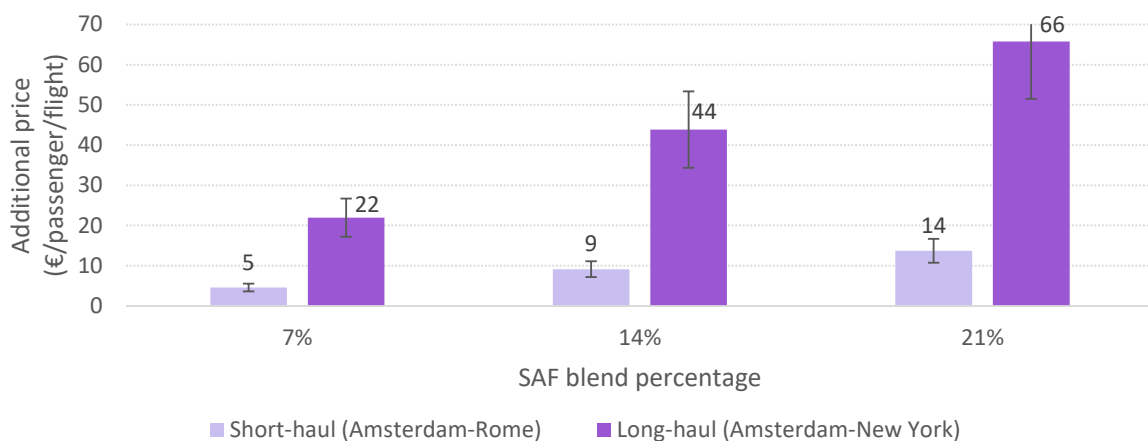

Figure 29: Additional flight price per passenger in case of green synthetic kerosene routes cost fully passed-on

¹⁸ Aircraft information from Source: ICCT, 2018, Transatlantic Airline Fuel Efficiency Ranking 2017, https://theicct.org/sites/default/files/publications/Transatlantic_Fuel_Efficiency_Ranking_20180912.pdf

The equivalent figures for blue synthetic kerosene routes in presented in

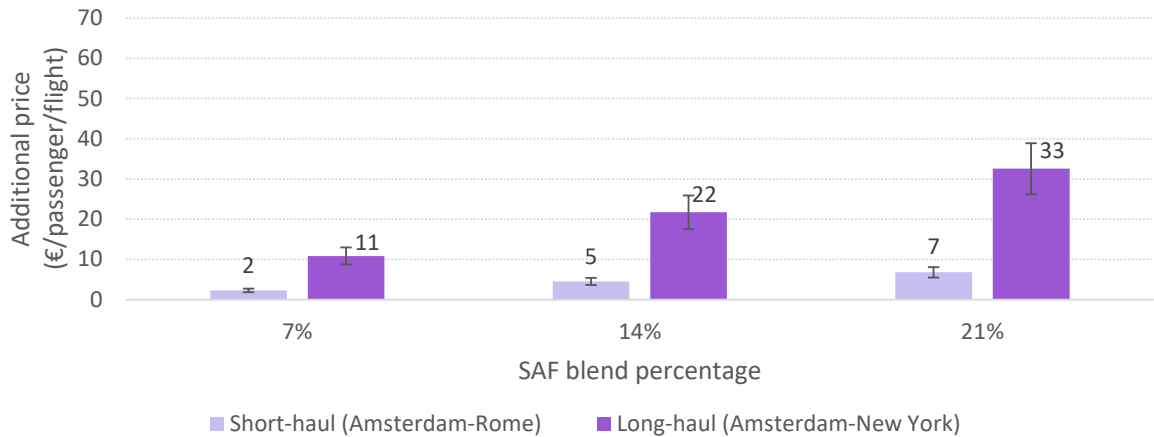

Figure 30, while the figures for CO routes appear in Figure 31.

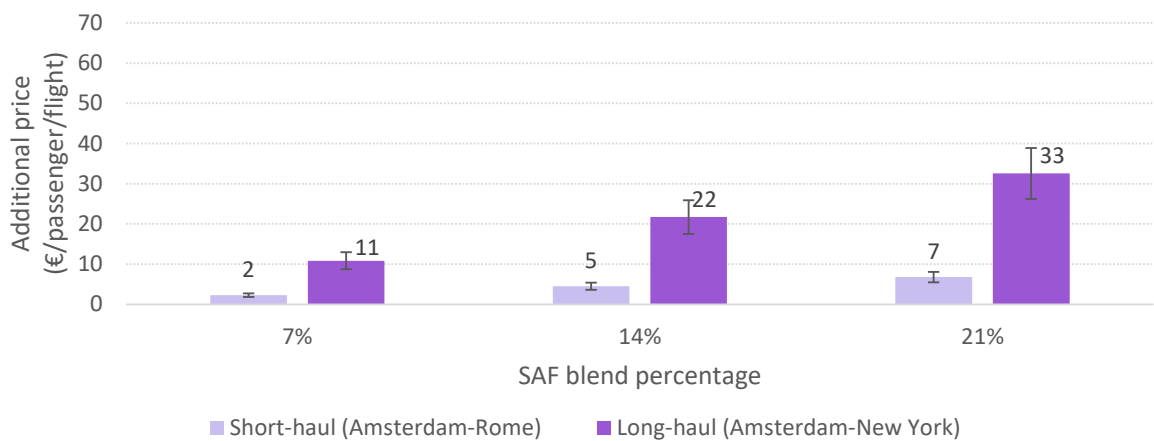

Figure 30: Additional flight price per passenger in case of blue synthetic kerosene routes cost fully passed-on

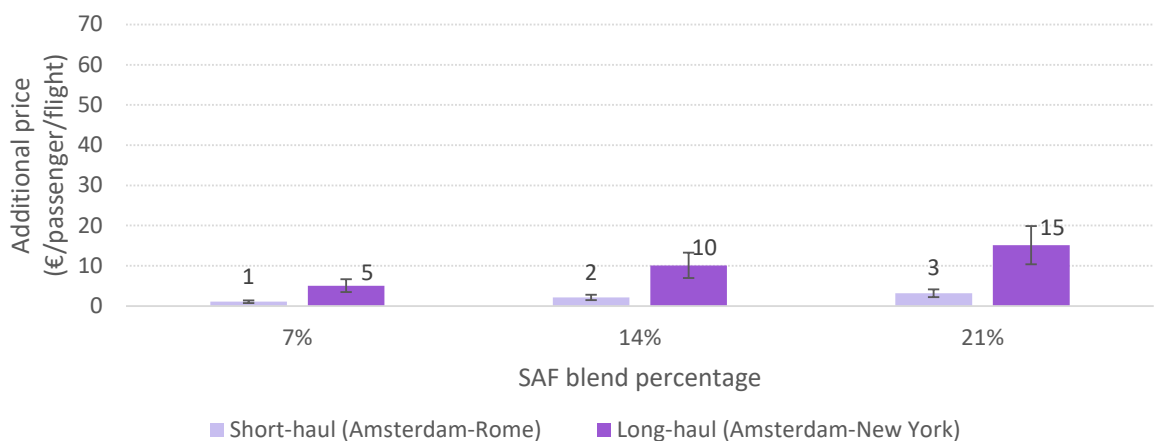

Figure 31: Additional flight price per passenger in case of CO synthetic kerosene routes cost fully passed-on

Under the 14% blend scenario, the implied increase on the short-haul ticket price is between 2% for CO routes and 9% for green fuel routes (assuming a one-way ticket price of €100¹⁹). Meanwhile an increase on the long-haul ticket price of between 3% and 11% (assuming a one-way ticket price of €400) for the same fuel pathways at 14% blending could be expected.

4.2 Capacity ramp-up and feedstock modelling

4.2.1 Status of synthetic kerosene routes and aviation industry

The scale up rate of synthetic kerosene routes depends on resource availability, ongoing commercialisation activities and current market trends. The current number of developers and ongoing or announced number of projects gives an indication of the deployment trends of individual synthetic kerosene routes. We assume that technology developers will scale up their technology to commercial scale and license their technologies once mature, and this will considerably drive the increase of synthetic kerosene supply.

The global nature of the technologies means that developments need to be assessed at a global scale. The data used for the ramp up potential assessment was collected at both European and global scale. Currently Europe dominates R&D activities. However, it is assumed that once the technology is scaled up and suitable to be deployed at commercial scale, technology developers are likely to start up new commercial plants outside of Europe.

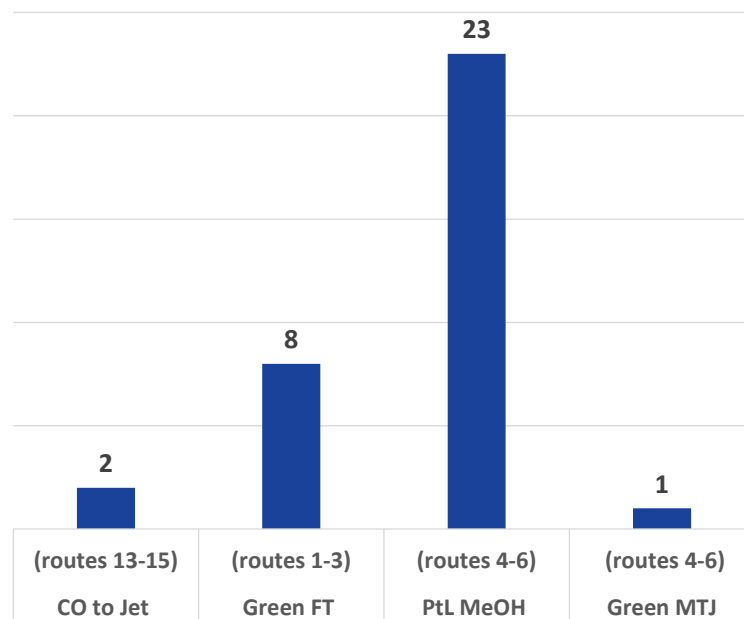

Figure 32 Number of e-synthetic fuel technology developers globally by route

¹⁹ These are indicative prices for Amsterdam-Rom one-way and Amsterdam-New York one-way at the end of January 2020, booked 2 months in advance. Prices have been taken from <https://www.skyscanner.net/>. Prices can vary significantly depending on airline, booking date, flight date, flight time, economy vs business class.

Methanol to Jet synthesis (MtJ)

Only one pilot project, KEROSyN100 led by the Advanced Energy Systems Institute at the University of Bremen in Germany, was identified for this route. Given the limited activity observed today (the route is still to be ASTM certified), the methodology adopted in the ramp up model will predict limited scale up potential for this conversion route. However, despite the very limited number of current MtJ technology developers, there is still potential for faster scale-up of this route, due to the large number of initiatives in power-to-methanol production, with Europe dominating development projects (Table 3).

Power-to-methanol is still an early-stage technology, with the majority of projects identified at pilot or demonstration scale. However, we also identified a small number of commercial scale projects particularly in industrial clusters. For example, the Port of Antwerp project aims to synthesise methanol from point source CO₂, for use in maritime and chemicals manufacture. The potential scale up of e-methanol for jet synthesis therefore needs to be considered in the context of wider industry activities and availability of e-methanol.

Today, the production of blue methanol is not practiced. As stated in section 3.1.4, lower carbon fossil methanol production is mainly driven by existing large fossil methanol players who produce methanol from natural gas and have installed carbon recovery units to recycle carbon and increase their output. Their facilities are therefore already at commercial scale and produce large volumes of product, but this is not blue methanol involving hydrogen with CCS. The addition of CCS to existing large-scale hydrogen facilities could happen relatively quickly, and could represent significant resource availability for the subsequent methanol-to-jet steps. However, to date, no operational or announced projects involve methanol production using a source of blue hydrogen produced with CCS. Hence, methanol-to-jet via blue methanol (routes 10-12) was not modelled in the ramp-up part of this study.

Fischer-Tropsch synthesis

Europe is leading the development of renewable power-to-liquids via Fischer-Tropsch synthesis (routes 1-3). Most developments identified are at small scale (pilot and demonstration plants), but some developers have also announced commercial scale projects (Table 2).

The use of blue hydrogen as input is a potential alternative to renewable power-to-FT liquids. Today, interest in the blue hydrogen + FT option (routes 7-9) appears very limited, and no technology developers have announced plans for blue hydrogen + FT jet plants. For this reason, in order to align with the modelling methodology adopted for other conversion technologies, the scale up potential of these routes were not modelled in this assessment. There are some limitations linked to this approach since new projects could potentially be announced by technology developers over the next few years, although this will also depend on their categorisation and GHG savings under RED II or other policies.

Finally, one technology developer has announced a large-scale Fischer-Tropsch to jet plant using steel mill CO as the main carbon source (route 14). This conversion process produces hydrogen via the WGS reaction prior to the Fischer-Tropsch synthesis. Alternatively, the CO could be reacted with purchased hydrogen to avoid the WGS reaction (route 15). In this assessment, this route has been modelled as “CO + Fischer-Tropsch synthesis” and the supply ramp up has been included in the “CO to Jet” category.

Developers deploying FT routes via fossil waste gases are likely to build larger scale plants even for *First of a kind* (FOAK) commercial plants, given that the component technologies deployed are proven at scale. For this reason, starting up a new CO + Fischer-Tropsch plant would have a considerable impact on the capacity scale up of this route.

Steel mill gas fermentation to ethanol to jet route

Similarly to the methanol-to-jet synthesis, the scale up potential of this route is treated in two separate parts. First steel mill gas fermentation produces the ethanol intermediate. LanzaTech is the pioneer of this conversion route and has formed partnerships with several steel producers.

The ethanol intermediate can then be upgraded to jet in a second step. Lanzatech has formed a partnership with Pacific Northwest National Laboratory (PNNL) and has spun-out a separate company, LanzaJet, to focus on the commercialisation of alcohol-to-jet, including integrated production onsite alongside ethanol production.

4.2.2 Short- and long-term outlook

The short and long-term scale up potential of synthetic kerosene routes is heavily influenced by ongoing activity and project developments. Depending on the time scale analysed, different approaches are used to estimate the synthetic kerosene ramp up potential, and as discussed in Section 3.2.2, two scenarios were developed to estimate the scale up of synthetic kerosene to 2030 and 2050 in Europe and globally. As explained above, routes involving blue hydrogen (routes 7-12) were not modelled in this ramp-up assessment, due to the lack of current activities in these routes.

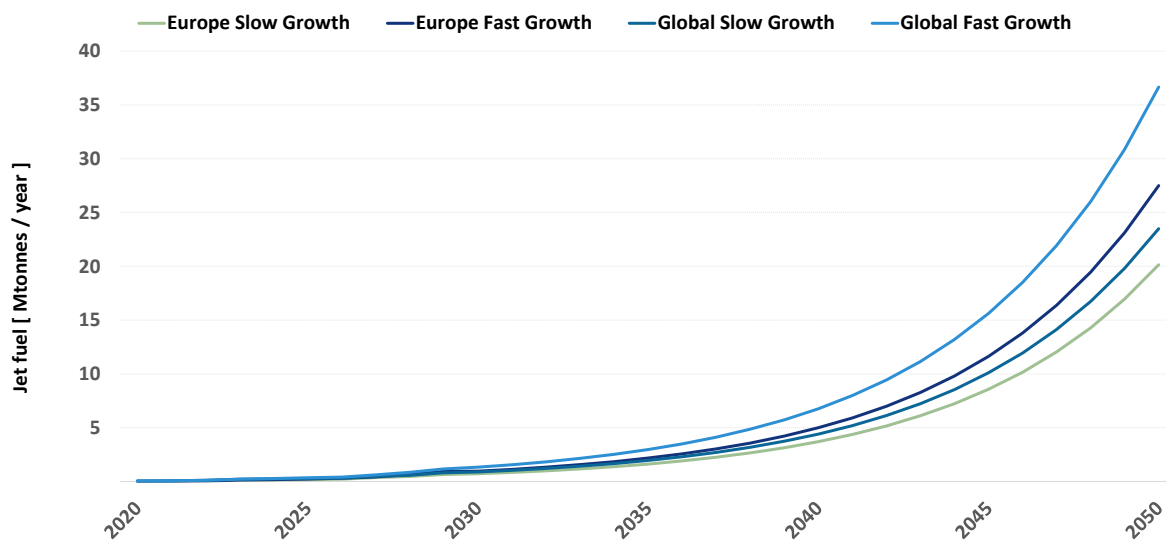

Figure 33: Cumulative capacity of all synthetic kerosene production routes to 2050.

Figure 33 shows the cumulative capacity build up in each of the scenarios to 2050. In the European fast growth scenario, the cumulative number of new synthetic kerosene plants increases from 6 in 2030 to 232 in 2050, with the green FT routes dominating the picture. These plant numbers are indicative, as they are based on the plant scales included in the model. Whilst these are representative of developers’ planned commercial scale plants today, in the future developers may choose smaller or larger plants depending on, among other things, the availability of resources, e.g. blue or green

hydrogen, and progression in technology minimum economic scales. Note that Europe remains a significant contributor to global supply to 2050, but this reflects how the model is designed which tends to perpetuate the split apparent in 2030.

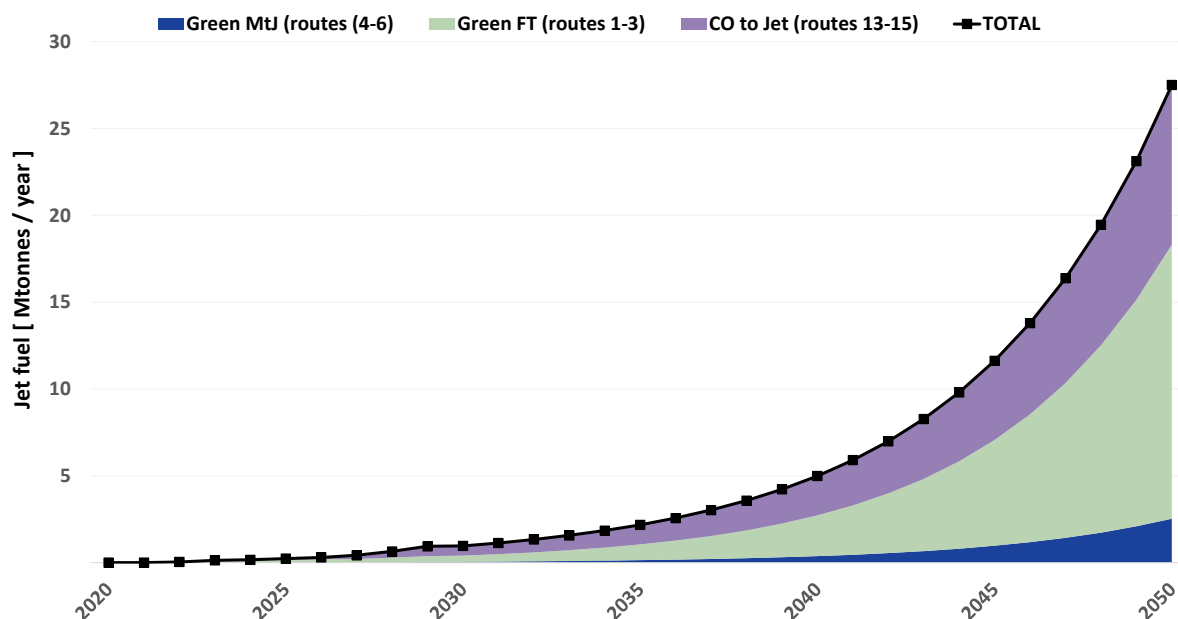

Figure 34: Route breakdown of synthetic kerosene fuels in Europe to 2050 under the fast growth scenario. Note that the CO to Jet route includes the CO fermentation to jet and the CO + Fischer-Tropsch synthesis routes. The ramp up results of alternative scenarios are presented in Appendix A

Figure 34 shows the breakdown of the overall European synthetic kerosene supply by route type to 2050 with the global outlook following a similar trend. Under the fast growth scenarios, the synthetic kerosene production in 2050 is estimated to reach 27 Mt/yr in Europe and 36 Mt/yr globally. For comparison, in the International Energy Agency’s (IEA) B2DS scenario²⁰, which aims to achieve net-zero emissions by 2060, global SAF demand in 2060 reaches 150 Mt/yr corresponding to 70% of the total aviation fuel demand (although this covers a range of SAF routes including synthetic jet).

The starting point for growth in the period 2030 – 2050 is based on the 2030 outlook, which in turn is based on the current state of the industry. Hence, routes that are the nearest to commercialisation today are likely to remain dominant in 2030 unless the emerging routes rapidly gain developers and realise new large projects. Based on the modelling approach, the production of synthetic kerosene in Europe is estimated to be able to reach 970 ktonnes/yr in 2030. This exceeds the implied demand under a number of 2030 mandates or targets being discussed in Europe currently: the EU’s ReFuelEU 0.7% mandate for synthetic jet represents ~300 ktonnes/yr; the German 2% mandate of for synthetic kerosene represents ~200 ktonnes/yr; and the Dutch 14% target for all SAF represents ~700 ktonnes/yr.

In 2030, the green FT route dominates the fast growth scenario for Europe, representing approximately 36% of the total synthetic kerosene supply. The methanol-to-jet route makes up the smallest share of

²⁰ In the B2DS scenario “technology improvements and deployment are pushed to their maximum practicable limits across the energy system in order to achieve net-zero emissions by 2060 and to stay net zero or below thereafter, without requiring unforeseen technology breakthroughs or limiting economic growth”.

the European synthetic kerosene supply, 6%, given the very early stage of this technology today. Since Europe dominates global production of green FT jet today, this is expected to remain the case in the short term.

At global scale, the picture in 2030 is slightly different, with the total production capacity predicted to reach approximately 1.3 Million tonnes under the fast growth scenario with the CO to jet and the green FT routes predicted to supply approximately 35% and 61% of the total synthetic kerosene production respectively.

For modelling purposes, CO based routes (CO fermentation + ATJ in route 13 and CO + FT synthesis in routes 14-15) were grouped together under the “CO to Jet” classification.

The CO fermentation to jet route consists of two main conversion steps. First the fermentation of CO waste gas to an ethanol intermediate, followed by upgrading conversion to jet via the alcohol-to-jet process. Our analysis projects strong capacity scale up potential for route 13 based on current ATJ technology developers being able to rely on a broad pool of alcohols, including advanced ethanol from biogenic or from waste fossil feedstocks (Figure 35). This suggest that the jet synthesis step is unlikely to be the bottleneck in the scale up of the CO to jet route. Instead, the build-up rate of the initial CO fermentation step will likely limit the rate of growth of this route, since the model currently includes LanzaTech as the sole technology developer.

In the European fast growth scenario, CO + FT routes (routes 14+15) could represent about 24% of the total synthetic kerosene supply in 2050. This is based on one known large-scale project today, however, this number could be considerably higher if more technology developers commission projects before 2030. Considerations linked to the availability of CO waste gases will be discussed in the feedstock section below.

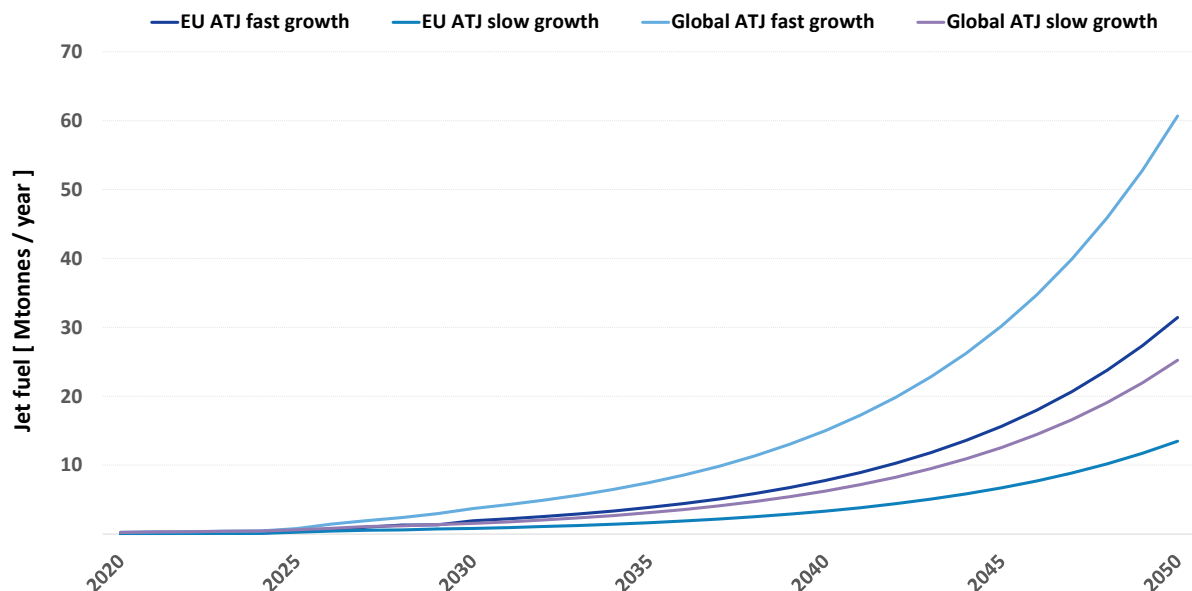

Figure 35: Capacity scale up of alcohol-to-jet using advanced ethanol (lignocellulosic, MSW) to 2050.

The higher growth rate attributed to the green FT routes means that by 2050, in the fast growth scenario, this route is estimated to represent 57% of the total synthetic kerosene supply at both Europe

and global level. While the number of power-to-jet producers is still relatively small today (1 for MtJ and 8 for PtL FT), ongoing activity in the wider power-to-liquids context and interest for a wide range of industries could considerably accelerate the scale up of these technologies.

The methodology applied takes a conservative approach to model synthetic kerosene technologies at an early stage of development. Methanol-to-Jet is an emerging technology with limited activity to date, the ramp up of this route to 2030 is therefore relatively small. Beyond 2030, the 21% annual growth rate applied reflects the possibility of new players entering the market, and faster growth rate of new plants based on existing activity. As discussed above, the large-scale deployment of the methanol-to-jet routes is linked to developments in the wider power-to-liquids field, in particular power-to-methanol, and the aviation industry has demonstrated growing interest in the power-to-methanol technology by joining other technology developers involved in these types of projects. Earlier entry into the market of new players could accelerate the overall ramp up to 2050. Contrary to the CO fermentation to jet route, in this case the factor limiting growth is the jet synthesis step rather than the production of the methanol intermediate. As stated in section 3.2.2, no ongoing or planned projects were identified for the blue FT or blue methanol synthesis, so the ramp up for these routes (routes 7-12) are therefore not modelled in the supply model to 2050. This assessment is based on today's picture, which reflects the considerable uncertainty amongst technology developer around whether blue hydrogen routes will receive favourable policy treatment. If there are positive policy signals that blue hydrogen + CO₂ routes to synthetic kerosene are to be considered as sufficiently low carbon, scale up could be achieved quickly given the relatively large nameplate capacities of blue FT and blue MTJ plants and the abundance of natural gas. Even interest from a relatively small group of players between now and 2030 could significantly increase the supply of jet from this route.

4.2.3 Resource availability

The sustainable scale up of synthetic kerosene capacity will be critically dependent on there being sufficient supply of the inputs such as renewable power and natural gas but also intermediate feedstocks in the case of the alcohol-based routes. The following section addresses the implications of resource availability on the scale up scenarios of synthetic kerosene.

Renewable Electricity

The fast growth scenarios show that by 2030 an estimated 16 TWh/year in Europe and 21 TWh/year of renewable electricity globally would be required to supply the green hydrogen based synthetic kerosene routes as predicted by the ramp up model (Figure 36). Wind Europe's central scenario to 2030 estimates 888 TWh/year of renewable power supply from onshore and offshore wind-power in Europe by 2030²¹. The IEA's Sustainable Development Scenario estimates about 15,000 TWh/year for all renewable power generation globally by 2030²².

These numbers indicate that to 2030 demand for electricity for synthetic kerosene is likely to be small and not lead to significant competition with demand in other sectors.

²¹ Wind Europe, (2017), available at: <https://windeurope.org/wp-content/uploads/files/about-wind/reports/Wind-energy-in-Europe-Scenarios-for-2030.pdf>

²² IEA, Available at: <https://www.iea.org/reports/renewable-power>

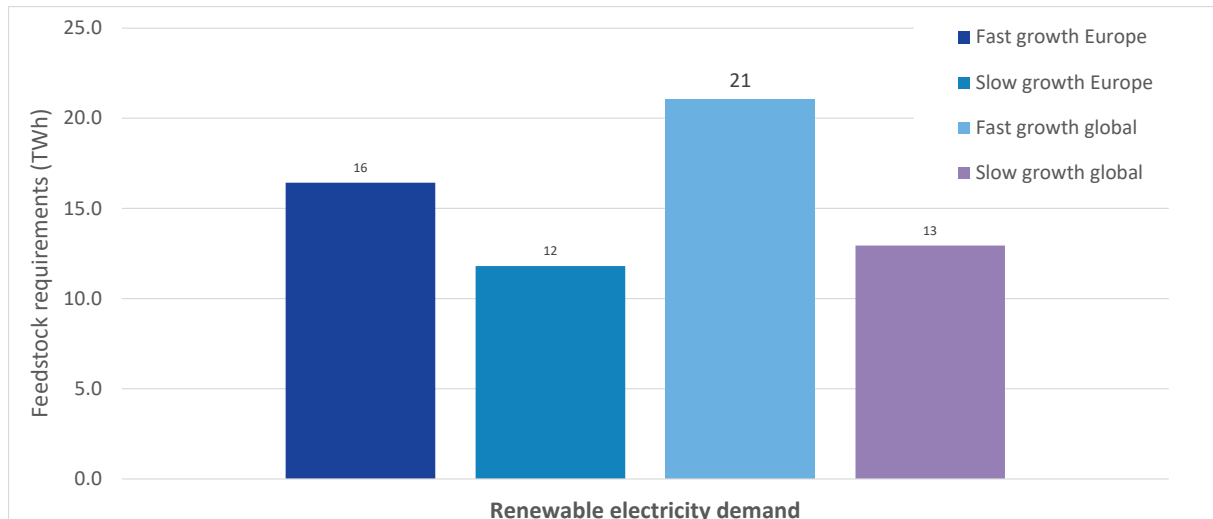

Figure 36: Renewable Electricity requirements (TWh) in 2030 for all scenarios.

To be economically efficient, synfuel conversion plants need to have access to a supply of low-cost renewable power with high full load hours (FLh). Analysis of synfuel production costs based on hybrid PV and wind systems by Breyer and Fasihi²³ shows that synfuels plants should ideally be located in areas with high FLh if they are to achieve lowest production costs and limited storage requirements (see Figure 37). These are typically areas with both high PV and wind capacity e.g. Middle East and North Africa, where renewable power is cheap and supply potentially higher than local demand²⁴.

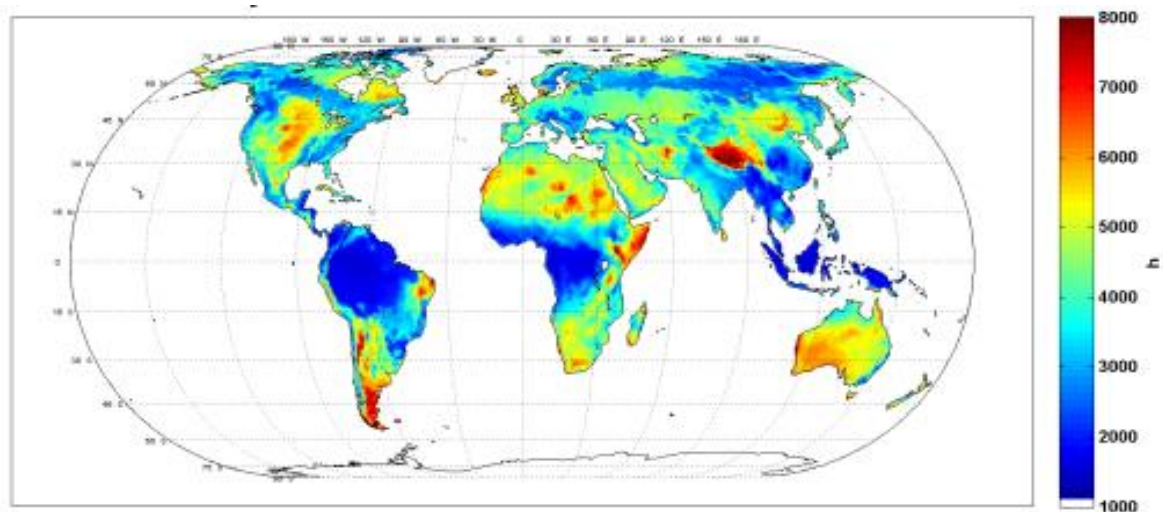

Figure 37: Hybrid PV-Wind cumulative FLh in 2005²⁵

²³ Direct Air Capture of CO₂: A Key Technology for Ambitious CC Mitigation 2019 Joule 3(9) Breyer and Fasihi

²⁴ Role of e-fuels in the European transport system - Literature review, Concawe (2020), available at: https://www.concawe.eu/wp-content/uploads/Rpt_19-14.pdf

²⁵ Direct Air Capture of CO₂: A Key Technology for Ambitious CC Mitigation 2019 Joule 3(9) Breyer and Fasihi

Power can also be supplied through the main electricity grid but this would result in hydrogen which is not fully green until such time as the grid is completely decarbonised (nearer 2050).

Competition for renewable power is likely to be strong with renewable capacity currently mainly being used to displace high carbon generation on the grid (coal and gas power). Ultimately, the prioritisation of the use of renewable power for different sectors will depend on various policy incentives. Figure 38 shows the current GHG emissions saved for the use of 1MWh of renewable electricity in different end sectors for a country that relies on fossil fuel transport and natural gas heating (such as the Netherlands or the UK). The ranking suggests other uses are likely to be currently prioritised over synthetic kerosene as the supply of renewable power is still limited today. However, as the power sector, heating and light duty road transport become progressively more decarbonised, this ranking will shift, and greater attention will turn to decarbonising aviation through the use of synthetic kerosene routes. It should also be noted that the use of synthetic kerosene in aviation could bring non-CO₂ benefits (e.g. reduced soot leading to improved air quality and reduced warming from cirrus cloud formation) which are the subject of ongoing research, and are not factored into this analysis.

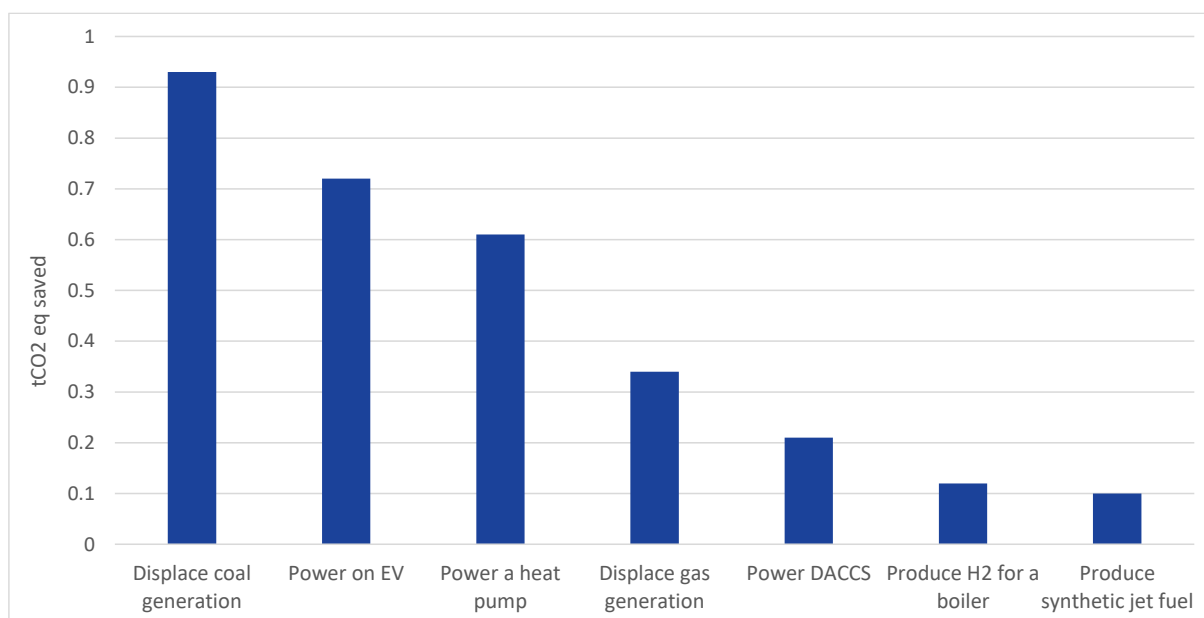

Figure 38: Current emissions saved by using 1MWh of zero carbon electricity²⁶

One study estimates that replacing 50% of the EU’s aviation fuel demand in 2050 with renewable synthetic kerosene would require a quarter of the EU’s current electricity generation²⁷. While studies vary in the predicted growth of synfuels they agree on the need to significantly increase the production of renewable electricity to ensure additional renewable electricity is available over time to satisfy a wider range of applications.

²⁶ Climate Change Committee, ‘The sixth carbon budget: Electricity Generation’(2020), available at: <https://www.theccc.org.uk/wp-content/uploads/2020/12/Sector-summary-Electricity-generation.pdf>

²⁷ Cerulogy (2017) p.6, Available online: https://www.transportenvironment.org/sites/te/files/publications/2017_11_Cerulogy_study_What_role_electrofuels_final_0.pdf

Carbon dioxide sources

The production of synthetic kerosene, except for routes which use recycled CO as discussed further below, require a source of CO₂. Approximately 4.15 tonnes of CO₂ are required to produce one tonne of synthetic fuel via the Fischer-Tropsch synthesis and 4.86 tonnes of CO₂ via the methanol-to-jet route²⁸. The resulting CO₂ demand for these routes for each of the modelled scenarios to 2030 is presented in Table 7.

Table 7: Estimated CO₂ supply needed to meet green synthetic kerosene demands in 2030

Scenario	Estimated synthetic kerosene production (ktonnes jet/yr)	Estimated CO ₂ demand (ktonnes CO ₂ /yr)
	2030	
Europe fast growth	670	2900
Europe slow growth	310	1300
Global fast growth	900	3800
Global slow growth	560	2300

As discussed in section 2.3, CO₂ can be supplied either from DAC or from point source capture at industrial sites (CCU).

The rate of deployment of DAC systems is initially dependent on the number of technology developers and their individual scale up capability (Table 8). Over time, factors such as the availability of low-cost renewable electricity²⁹ or heat inputs to DAC systems are likely to be more significant determinants.

²⁸ Based on internal E4tech calculations.

²⁹ 'CO₂ DAC for effective CC mitigation based on RE', Breyer & Fasihi, Mitigation and Adaptation Strategies for Global Change volume 25, 43–65, 2020

Table 8: Current status of DAC technology developers and plants

Company	Plants	Largest plant	Tech Type	Energy source	Future plans
Carbon Engineering	1	1 t/day	HT aqueous solution	Natural gas (CO ₂ is captured) and renewable power	Developing plant in US to remove 1 MtCO ₂ /year ³⁰ Work with Pale Blue Dot Energy on UK commercial- scale DAC plant ³¹
Global Thermostat	2+ (co-located w/ industrial plants)	4000 t/year	LT solid sorbent (TSA)	Waste heat (electricity needs not stated)	Partner with ExxonMobil to scale up and remove 1 GtCO ₂ /yr and expand to 40 GtCO ₂ /yr ^{32 33}
Climeworks	14	900 t/year	LT solid sorbent (TSA)	Renewable electricity or waste heat	Project Orca to capture 4000 tCO ₂ /year in Iceland. 3 more plants in planning or production ³⁴
Airthena	1	6 kg CO ₂ /day	LT solid sorbent (TSA)	Renewable electricity	Planned field trials ³⁵
Hydrocell	1	3.8 kg/day	LT solid sorbent (TSA)	Renewable electricity (solar)	Partner in the Soletair project aiming for 100% renewable consumer products ^{36 37}
Carbyon	1	Bench	LT solid sorbent (TSA)	Renewable electricity	Working with Dutch research institutions to maximise efficiency ³⁸
Infinittree	1	Bench	LT solid sorbent (MSA)	Unknown	Little information ³⁹
Silicon Kingdom Holdings	1	Bench	LT solid sorbent (MSA)	No energy for capture but unknown for sorbent regen., compression etc	Deploy small-scale in 2021 to capture 1-2 tCO ₂ /day to expand to 30 tCO ₂ /day and eventually 4MtCO ₂ /year ^{40 41}
Skytree	1	Bench	LT solid sorbent (MSA)	Waste heat	First product will be in air-quality management in electric vehicles ⁴²
Prometheus Fuels	1	20, 000 t/year ⁴³	Unknown	Renewable electricity	Aim to sell fuel late 2021. Other products for CO ₂ ⁴⁴ use in pipe

³⁰ Carbon Engineering, 2020 <https://carbonengineering.com/>

³¹ Lammey, 2020 "UK's first commercial-scale direct air capture plant to be based in north-east" <https://www.pressandjournal.co.uk/fp/business/north-of-scotland/2495944/uks-first-commercial-scale-direct-air-capture-plant-to-be-based-in-north-east/>

³² Global Thermostat, 2020 <https://globalthermostat.com/>

³³ Soltoff, 2019 "Inside ExxonMobil's hookup with carbon removal venture Global Thermostat" <https://www.greenbiz.com/article/inside-exxonmobils-hookup-carbon-removal-venture-global-thermostat>

³⁴ Climeworks, 2020 <https://www.climeworks.com/>

³⁵ Sadiq et al, 2020 "A Pilot-Scale Demonstration of Mobile Direct Air Capture Using Metal-Organic Frameworks" <https://onlinelibrary.wiley.com/doi/10.1002/adsu.202000101>

³⁶ Hydrocell, 2020 <https://hydrocell.fi/en/air-cleaners-carbon-dioxide-filters-and-dac-appliances/dac-appliances/>

³⁷ Bajamundi et al, 2019 "Capturing CO₂ from air: Technical performance and process control improvement" <https://reader.elsevier.com/reader/sd/pii/S2212982018310187?token=4CE9DD02A585A69316300EBB2C0AD6C9066FBEBB34FD5574A8A905AAB0CFABAD4F2983C363454E6C30D63B2339B07E87>

³⁸ Carbyon, 2020 <https://carbyon.com/>

³⁹ Infinittree, 2017 <http://www.infinittree.com/>

⁴⁰ Ortega, 2020 "The world's first mechanical tree prototype is to be built at ASU next year" <https://www.statepress.com/article/2020/10/spbiztech-the-worlds-first-mechanical-tree-is-to-be-built-at-asu-by-next-year#>

⁴¹ Silicon Kingdom Holdings <https://mechanicaltrees.com/>

⁴² Skytree, 2020 <https://www.skytree.eu/>

⁴³ Prometheus Fuels state that in a year their technology "turns 20 kilotons of atmospheric CO₂ into one million gallons of gasoline, diesel, or jet fuel" <https://www.prometheusfuels.com/technology/>

⁴⁴ Prometheus Fuels, 2020 <https://www.prometheusfuels.com/>

Point source CO₂, captured either from fossil or biogenic sources, presents an alternative to DAC especially in the short term. Table 9 gives an overview of potential CO₂ sources from a range of industrial processes. Using point source CO₂ to produce synthetic kerosene is lower cost than DAC and presents lower technology risks, which could be important to proving synthetic kerosene production at scale. However, the use of point source CO₂ for synfuels introduces the risk of prolonging CO₂ emissions from fossil sites and concerns over ‘lock-in’ to fossil sources or higher emissions technology.

Table 9: Classification of potential CO₂ sources including the typical CO₂ concentrations⁴⁵

CO2 from combustion processes	CO2 as by-product from industrial processes			CO2 from the atmosphere
	Biotechnological processes	Chemical Industry	Industrial Production	
Coal 12-15 vol.%	Biogas upgrading 40 vol.%	Ethylene 12 vol.%	Cement 20 vol.%	Ambient air 0.039 vol.%
Natural Gas 12-15 vol.%	Bioethanol Up to 100 vol.%	Ammonia Up to 100 vol.%	Iron and Steel 15 vol.%	
Oil 3-8 vol.%	Fermentation Up to 100 vol.%	Refineries 3-13 vol.%		
Biomass 3-8 vol. % Waste sources 12 vol. %				

The concentration of CO₂ at the point of capture affects the cost and efficiency of the process and sources that produce CO₂ streams of over 95% purity are ideally placed to be ‘first-movers’ for industrial CCU, as expensive separation of the CO₂ is not required. Industries where such sources are available include natural gas processing, bioethanol/biofuel plants (including biomethane upgrading from biogas), ammonia production, ethylene oxide production and hydrogen production⁴⁶. Fossil fuel lock-in could be avoided by progressive fuel switching to biogenic sources in industrial processes.

A review of the literature on the availability of point source CO₂ for synthetic fuels (including kerosene) production⁴⁷ suggests that sufficient CO₂ is likely to be available to meet the demand of synthetic fuels production (Table 10).

Table 10: European (EU 27 + UK) Potential CO₂ availability from concentrated sources, according to different references analysed in the Concawe synfuels literature review⁴⁸

References used	Potential CO ₂ availability from concentrated sources (Mtonnes/yr)	
	2030	2040
ICCT (2017)	896	680
LBST and dena (2017)	165	165
Dechema (2017)	952	516

⁴⁵ Assessing the potential of CO₂ valorisation in Europe – Rodin et al Journal of CO₂ utilization 41, 2020, 101219

⁴⁶ IEA Report ‘CCUS in clean energy transitions’, Available at: <https://www.iea.org/reports/ccus-in-clean-energy-transitions/a-new-era-for-ccus#growing-ccus-momentum>

⁴⁷ Role of e-fuels in the European transport system - Literature review, Concawe (2020), available at: https://www.concawe.eu/wp-content/uploads/Rpt_19-14.pdf

⁴⁸ Role of e-fuels in the European transport system - Literature review, Concawe (2020), available at: https://www.concawe.eu/wp-content/uploads/Rpt_19-14.pdf

While the use of concentrated carbon sources is expected to dominate synthetic kerosene production in the short term, the continued use of fossil sources is incompatible with reaching carbon neutrality. A progressive shift to DAC technologies or biogenic point sources is required in the longer term. In a recent study Breyer et al (2020) have projected that CO₂ demand for synfuels will initially be supplied from concentrated sources, but will change to DAC over time (Figure 39)⁴⁹. This assumes point source CO₂ is either biogenic or from sources of CO₂ that are more difficult to eliminate (e.g. waste incinerators, cement manufacture). Breyer et al project that by 2050, DAC will be an essential technology for achieving net zero emissions with 80% of all CO₂ raw material provided by DAC and the remaining demand covered by point sources (Figure 39)⁵⁰.

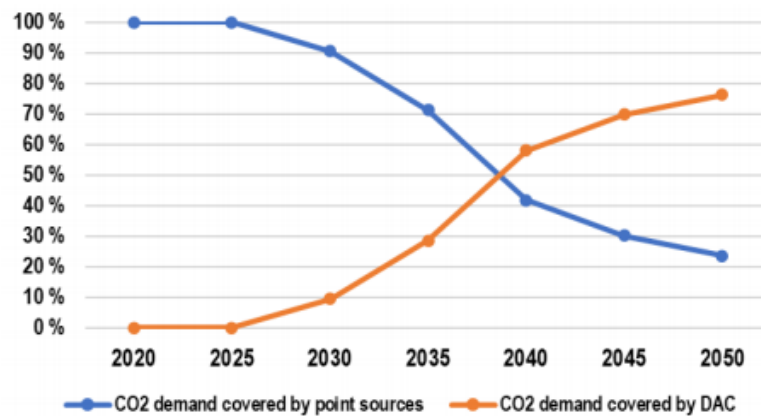

Figure 39: CO₂ supply for SNG, synfuels and methanol synthesis in Europe⁵¹

Natural Gas

The blue synthetic kerosene routes rely on hydrogen derived from natural gas reforming. The CO₂ emissions generated during the process are captured via dedicated carbon capture and storage (CCS) facilities. The distribution infrastructure is widely established at a global scale further suggesting that the supply of natural gas will not limit the growth of blue synthetic kerosene routes. The most important bottleneck in the scale-up of blue hydrogen based synthetic kerosene routes is likely to be the rate at which CCS facilities can be deployed.

CCS technologies have been identified as an important factor to reach the climate goals outlined by the Intergovernmental Panel on Climate Change (IPCC). Many scenarios developed require over 1000 gigatons of CO₂ stored underground by the end of the century, yet the availability of underground CO₂ storage capacity is still highly uncertain⁵². In Europe, the realisation of large-scale CCS projects has been quite challenging with many projects being put on hold or even cancelled⁵³. The utilisation of CCS was mainly driven for use for enhanced oil recovery, this, however, is unlikely to be sufficient to support the growth in CCS technologies needed to reach the net zero targets⁵⁴.

⁴⁹ Powerfuels in a Renewable Energy World Study presentation Breyer and Crane 2020

⁵⁰Powerfuels in a Renewable Energy World Study presentation Breyer and Crane 2020

⁵¹ Powerfuels in a Renewable Energy World Study presentation Breyer and Crane 2020

⁵² Zahasky C, Krevor S. Global geologic carbon storage requirements of climate change mitigation scenarios. Energy & Environmental Science. 2020;13(6):1561-1567.

⁵³ EU Science Hub, Available at : <https://ec.europa.eu/jrc/en/research-topic/carbon-capture-utilisation-and-storage>

⁵⁴ IEA Report 'CCUS in clean energy transitions', Available at: <https://webstore.iea.org/download/direct/>

Additional policies and financial mechanisms may be required to incentivise the CCS from power generation to other industries and thereby to allow the sustainable growth of CCS technologies⁵⁵.

An advantage of CO₂ capture technologies is that they can be retrofitted and added to existing industrial plants. This is especially interesting for relatively new industrial facilities which could remain operational for the next decades. For example, on average a European fossil-based plant remains operational for 35 years (this applies to coal-fired plants) while the emissions associated with industrial plants depend on the subsector (cement, chemical etc)⁵⁶. Ways to reduce the emissions include retrofitting these facilities with CCS technologies or shut down the plants early.

While the cost of electrolysis-based hydrogen is predicted to decrease in the coming years, CCS could present a good opportunity to address the GHG emissions of existing hydrogen production plants, accounting for 800 MtCO₂/year today⁵⁷. Post 2030, this assessment assumes growth in blue hydrogen production facilities (either new build reformers with CCS or retrofitting of CCS to existing SMRs) of 11% a year. This number is based on the global capacity of CO₂ capture from large scale natural gas facilities of 9.2Mt in 2019 to 26.9 Mt in 2030⁵⁸.

Intermediate feedstock

The methanol-to-jet and CO fermentation to jet routes rely on methanol and ethanol, with their scale up potentials modelled as “intermediates” in this assessment. Methanol can be produced via renewable power-to-methanol or blue methanol routes, while in the scope of this study ethanol is produced via the fermentation of steel mill waste gases. In the short term, the ramp up of these intermediates has been estimated using the same modelling approach adopted for the jet synthesis routes (see section 3.2.2).

LanzaTech is the only technology developer fermenting fossil off-gases into ethanol which explains the low scale up of this route. The availability of steel mill off-gas will be discussed in a dedicated section below. The large-scale production of CO based ethanol is a prerequisite for the large-scale capacity potential of the CO based jet synthesis. For this reason, the ramp up of CO-based ethanol will limit the scale up potential of the entire route to jet.

The model predicts strong scale up potential for methanol in 2050 (Figure 40), based on a large number of developers with currently smaller-scale facilities. To date the number of methanol-to-jet initiatives is very limited, projects for low carbon methanol on the other hand are relatively abundant. In particular renewable power-to-methanol benefits from strong activity in the wider power-to-liquids sector. Project consortia are generally led by players from various industries, in some cases including airlines. To date, there are no blue methanol development projects, for this reason the potential of blue methanol as intermediate feedstock was not modelled in this assessment. Methanol is a versatile chemical with applications in many industries including the chemical sector, road transportation and the shipping industry. This suggests potential competition for intermediate methanol between different end sectors, however, analysis of this competition is out of the scope of this study.

⁵⁵ EU Science Hub, Available at : <https://ec.europa.eu/jrc/en/research-topic/carbon-capture-utilisation-and-storage>

⁵⁶ IEA Report ‘CCUS in clean energy transitions’, Available at: <https://webstore.iea.org/download/direct/4191>

⁵⁷ IEA Report ‘CCUS in clean energy transitions’, Available at: <https://webstore.iea.org/download/direct/4191>

⁵⁸ 57

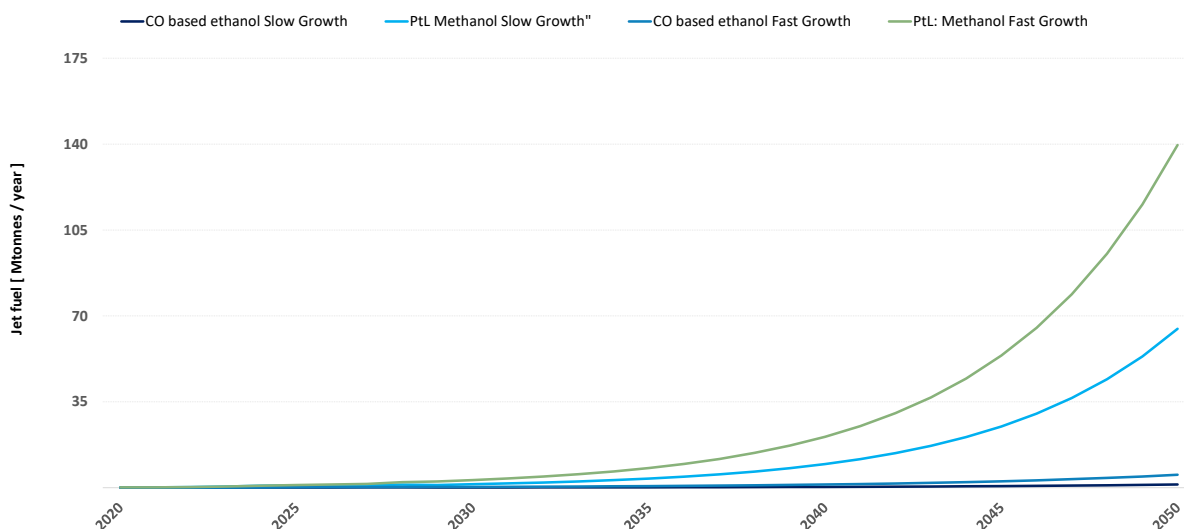

Figure 40: Europe, capacity scale up of “intermediates” to 2050 for all scenarios. (CO based ethanol refers to the Steel mill gas fermentation to ethanol route)

Steel mill off gas availability

Steel mill waste gas streams represent a potential resource for fermentation into low carbon ethanol or for FT synthesis into jet. As introduced above offgas from steel industries represents a significant source of GHG emissions and integrated steel mills are therefore a good candidate for point source carbon capture⁵⁹. The largest single point source at a steel mill is the blast furnace, from which 65% of the emissions can be captured. Blast furnace gas (BFG) can be used for electricity production in some integrated plants, or as a feedstock for bio-ethanol (STEELANOL project) or ammonia or methanol (Carbon2Chem project), so if the CO from BFG is to be used for synfuel synthesis it should be confirmed that this gives the greatest lifecycle GHG benefit.

Today the availability of sources of CO from industrial processes are fairly widespread, however these may not be as geographically dispersed as CO₂ sources. This could potentially limit the locations where this technology could be used. According to LanzaTech, the current availability of steel mill emissions is estimated to equate to 110 billion litres of ethanol annually⁶⁰, which could produce 50 Mtonnes/year⁶¹ of jet. While quantities of CO are not limited today these could be expected to reduce over time unless the CO is sourced from other feedstocks such as from biogenic sources. However, the IEA also estimates that over 40% currently operational steel manufacturing assets could still be operational in 2050⁶².

⁵⁹ Leeson et al. 'A Techno-economic analysis and systematic review of CCS'. International Journal of Greenhouse Gas Control, Volume 61, 2017, Pages 71-84

⁶⁰ LanzaTech (2017), Available at: https://www.energy.gov/sites/prod/files/2017/07/f35/BETO_2017WTE-Workshop_SeanSimpson-LanzaTech.pdf

⁶¹ Calculated from 30bn gallons of EtOH from steel mill waste gas, assuming a conversion yield (MJ fuel/MJ ethanol) of 91%.

⁶² IEA Report 'CCUS in clean energy transitions', Available at: <https://www.iea.org/reports/ccus-in-clean-energy-transitions/a-new-era-for-ccus#growing-ccus-momentum>

The CO to jet routes (routes 13-15) represent an option to recycle waste gas streams into useful end products, instead of generating power. Overall, between 59 and 98 Mtonnes/year of input CO⁶³ would be required to meet the jet fuel capacity as estimated in the ramp up scenarios in 2050, i.e. between 7 and 13 Mtonnes/yr. This suggests that the availability of CO sources is unlikely to limit the scale up of CO-based jet routes. However, as discussed above, the ramp up model assumes the limited number of technology developers involved in these conversion technologies to represent the major bottleneck for the scale up of the CO to jet routes. This means that the methodology applied could underestimate the supply of jet fuel via CO sources.

Water considerations

Water could also be considered as a resource subject to availability constraints, given its input into the production of synthetic kerosene. The net water demand can be estimated from the amount needed for electrolysis or gas reforming as well as from water required and/or generated in further downstream processing steps. The theoretical minimum amount of water required is approximately 1.3 to 1.4 litres of water per litre of jet fuel⁶⁴, but will be higher in reality given the actual performance of the conversion technologies and heating/cooling equipment applied.

Local water availability could therefore become an issue if water supplies in specific locations are already under stress⁶⁵, but will need be considered on a case-by-case basis when setting up a new hydrogen production or synthetic kerosene plants. However, the water consumption for synthetic kerosene production is negligible compared to biofuels routes.⁶⁶

4.2.4 Certified supply routes and routes in certification process

There are currently 8 ASTM certified production routes for SAF, with a number of other routes in the certification process and several other routes that are not in the certification process yet, but that could reach approval by 2030. The technical and commercial status of all these routes is presented and summarised in Table 11.

⁶³ The amount of CO required was calculated according to the following ratio: for the CO fermentation to jet route, 6.3 tonnes of CO for 1 tonne of jet fuel and for the CO + FT route 8 tonnes of CO for 1 tonne of jet fuel, multiplied by the predicted volume of CO fermentation to jet estimated for all growth scenarios.

⁶⁴ Power-to-Liquids Potentials and Perspectives for the Future Supply of Renewable Aviation Fuel (2016), Available at: <https://www.umweltbundesamt.de/publikationen/power-to-liquids-potentials-perspectives-for-the>

⁶⁵ Schmidt and Weindorf report a carbon number distribution between 8 and 16 (8–16 carbon atoms per molecule) for jet fuel, Power-to-Liquids Potentials and Perspectives for the Future Supply of Renewable Aviation Fuel (2016), available at: http://www.lbst.de/news/2016_docs/161005_uba_hintergrund_ptl_barrierefrei.pdf

⁶⁶ For biofuels a factor of 400 to 15,000 more water needed compared to power-to-liquids production from renewable electricity, Power-to-Liquids Potentials and Perspectives for the Future Supply of Renewable Aviation Fuel (2016), available at: http://www.lbst.de/news/2016_docs/161005_uba_hintergrund_ptl_barrierefrei.pdf

Table 11: Summary of SAF routes development status

Route	Certification ⁶⁷	Technology status	Global volumes of jet fuel produced in 2018 (kt/y)
Hydroprocessing oils/fats	HEFA-SPK up to 50% blend	Commercial (TRL 8)	17
Catalytic Hydro-thermolysis Synthesized Kerosene	CHJ	TRL to be confirmed	No commercial production
Hydro-processed hydrocarbons, esters and fatty acids	HC-HEFA-SPK, up to 10% blend	TRL to be confirmed	No commercial production
Co-processing oils/fats	D1655, up to 5% co-feed	Commercial (TRL 8-9)	No commercial production
Alcohols to Jet	ATJ-SPK up to 50% blend	Demonstration (TRL 6-7)	0.3
Fischer-Tropsch	FT-SPK up to 50% blend	Demonstration (TRL 6 for biogenic routes) or commercial (TRL 8-9 for fossil routes)	No commercial production
Fischer-Tropsch with Aromatics	FT-SPK/A up to 50% blend	Demonstration (TRL 6 for biogenic routes) or commercial (TRL 8-9 for fossil routes)	No commercial production
Hydroprocessed fermented sugars to synthetic isoparaffins	HFS-SIP up to 10% blend	Prototype (TRL 5) for lignocellulosic sugars, pre-commercial (TRL 7) for conventional sugars	No commercial production
IH² Pyrolysis + upgrading	Ongoing ^a	Demonstration (TRL 6)	No commercial production
Hydro-deoxygenation Synthetic Aromatic Kerosene	Ongoing (HDO-SAK)	Prototype (TRL 4-5) for lignocellulosic sugars, demonstration (TRL 5-6) for conventional sugars	No commercial production
Hydrothermal liquefaction	Pre-qualification stage	Demonstration (TRL 5-6)	No commercial production
Hydroprocessed Depolymerized Cellulosic Jet	Pre-qualification	TRL to be confirmed	No commercial production

a) IH² catalytic process developed by Shell is undergoing certification
 b) PtL FT jet fuel can be certified as FT-SPK as long as the FT synthesis is based on iron or cobalt catalysts⁶⁸

Hydroprocessing of oils and fats (HEFA)

Hydroprocessing of oils and fats is the most mature SAF route and the fuel produced through this route is certified for use by ASTM as HEFA-SPK in blends of up to 50%. The production process is the same as for Hydrotreated Vegetable Oil (HVO) but it uses a narrower hydrocarbon cut and includes an more severe isomerisation step that lowers the fuel freezing point. HEFA is the only type of SAF commercially used today dependence on waste or vegetable oil feedstocks could limit its availability over time. To

⁶⁷ CAAFI, Fuel qualification – Current status, accessed on Oct 2019, http://www.caafi.org/focus_areas/fuel_qualification.html

⁶⁸ D7566 specification, Annex1, article A1.4.1.1

reflect sustainability concerns, biofuels from waste oils and vegetable oils have limits to their contribution towards RED II targets but a variety of alternative crops are being investigated in terms of potential and sustainability. Larger volumes of HEFA SAF could potentially be supplied if High Freeze Point HEFA (HFP-HEFA) was approved as an aviation fuel. Given the similarity of HFP-HEFA to diesel HVO, approval would mean HVO capacity could, in principle, be quickly converted to HEFA provided market drivers were sufficiently strong.

Catalytic Hydrothermolysis Synthesized Kerosene (CHJ)

CHJ is a recent addition to ASTM D7566 Annexes and was officially approved in January 2020 with maximum blending of 50%. The CHJ process (based on hydrothermal liquefaction technology) consists of three main steps. In the first step clean free fatty acid (FFA) oil from the processing of waste oils is converted into a bio-crude oil inside the catalytic hydrothermolysis reactor. In the second step, the bio-crude oil undergoes hydrotreating and is converted into a mixture of several different hydrocarbons. Finally, this mixture is separated through distillation into single fractions (diesel, jet, gasoline). Research has shown that through the CH process, SAF can be produced from a variety of triglyceride-based feedstocks such as soybean oil, jatropha oil, camelina oil, carinata oil, and tung oil⁶⁹. Because the CH process uses waste or virgin vegetable oils, it faces similar challenges as the HEFA/HVO route regarding feedstock availability and sustainability. Additionally, the technology is still at an early stage and the fuel production cost is high relative to fossil jet⁷⁰.

Hydrocarbon-hydroprocessed Esters and Fatty acids (HC-HEFA-SPK)

HC-HEFA-SPK is the latest fuel addition to ASTM D7566 Annexes, approved in May 2020⁷¹. This is a HEFA-type fuel derived from micro-algae. The process to produce HC-HEFA-SPK is identical to the standard HEFA-SPK with the addition of a pre-treatment step. Micro-algae containing oils are first dried, and then the oil content is extracted using a solvent. The oil extracted then undergoes hydrotreating as in the standard HEFA process. IHI Corporation is developing this route based on a specific type of micro-algae called “*Botryococcus braunii*”. This species of micro-algae is particularly suitable for fuel production because it offers high oil yields compared to other types of feedstocks. The main challenges associated with micro-algae cultivation are the long-term stability and productivity of the crop, the overall process economics, and GHG emissions. Cultivation of micro-algae has relatively high energy consumption and associated GHG emissions if that energy is based on fossil sources.

Co-processed oils and fats

SAF can also be produced through co-processing oils and fats at refineries with the advantage of exploiting existing facilities and fuel distribution networks. Typical percentages of co-feed are between 5% and 10% of the total feedstock, although up to 30% co-processing has been achieved in some circumstances. Co-processing vegetable oils may require some equipment and plant set-up modifications, which are minimal below 5% but can become significant above this threshold⁷². The ASTM conventional jet fuel standard (D1655) limits co-processing of renewable lipids to 5%.

⁶⁹ <https://www.greencarcongress.com/2020/02/2020-0201-astmchj.html>

⁷⁰ Table A5, p99, <https://www.nrel.gov/docs/fy16osti/66291.pdf>

⁷¹ Green Car Congress, May 2020, <https://www.greencarcongress.com/2020/05/20200514-ihl.html>

⁷² Concauwe, 2019, “Refinery 2050: Conceptual Assessment”, PDF page 32, https://www.concauwe.eu/wp-content/uploads/Rpt_19-9.pdf

Alcohol to Jet (AtJ)

Alcohols produced through fermentation of sugar or starch crops or through advanced routes from lignocellulosic feedstocks, such as woody and grassy feedstocks, and wastes can also be catalysed to produce jet fuel. ASTM first certified ATJ-SPK bioblends up to 50%v/v in 2016. AtJ offers logistical flexibility because the alcohol catalysis plant does not need to be co-located with alcohol production, and alcohols can be conveniently transported and stored. Competition from direct use of alcohols in transport applications (e.g. road and marine), as opposed to converting them to jet fuel, is likely to be strong given the additional capital expenditure, efficiency loss associated with jet fuel production. The AtJ approach is being expanded through the addition of Alcohol to Jet Synthetic Kerosene with Aromatics (ATJ-SKA) which is similar to ATJ-SPK but contains a higher amount of aromatic compounds, which ensure the swelling of seals in current jet engines. ATJ-SKA, if approved, has the potential to be directly used in aircrafts without blending and the fuel is in Phase 1 – Testing of the ASTM certification process. Other variants in development include “Consolidated Dehydration and Oligomerisation” (CADO) which does not require the additional hydrogenation step typically present in the back end of more established ATJ routes.

Fischer-Tropsch synthesis (FT-SPK and FT-SPK/A)

All jet fuel produced by Fischer-Tropsch synthesis is ASTM qualified, regardless of the syngas feedstock (whether biogenic, fossil or atmospheric carbon). Jet fuel produced through gasification + FT (FT-SPK) was the first route to be certified in 2009 and can be blended with fossil kerosene up to 50%. While commercially mature for coal and natural gas-to-liquid routes, the bio-based route faces the challenge of scaling down FT synthesis and hydrocracking equipment to capacity levels suitable for biomass and waste-based gasification systems. One option for improving the economics could be co-process the intermediate FT waxes at existing oil refineries, rather than upgrading them in a dedicated hydroprocessing plant. This alternative refinery co-processing route has been certified by ASTM at up to 5% by volume.

Direct sugars to hydrocarbons (DSHC)

DSHC routes use genetically modified microorganisms to convert sugars into hydrocarbons or lipids. Three main routes are under development whose products can be further processed into jet fuel: heterotrophic algae or yeast converting sugars into lipids within their cells; genetically modified yeasts which consume sugars and excrete long-chain liquid alkenes (e.g. farnesene); genetically modified bacteria consuming sugars and excreting short-chain gaseous alkenes (e.g. isobutene). These currently use conventional sugar feedstocks, although pilot projects are testing cellulosic sugars. One specific route based on the production of farnesene from sugar is ASTM certified (HFS-SIP) and can be blended with fossil kerosene up to a maximum of 10%. The complexity and low efficiency results in high feedstock cost and high energy consumption, making DSHC an expensive SAF route.

Pyrolysis and upgrading

Pyrolysis can be used to transform lignocellulosic biomass or solid waste into an intermediate bio-crude oil, which can then be upgraded to aviation fuel. KiOR had embarked on ASTM certification of bio-kerosene from fast pyrolysis, before filing for bankruptcy but now Shell is in Testing Phase 1 of ASTM D4054 for its catalytic pyrolysis process (IH²). There is no commercial process for upgrading pyrolysis oil to finished fuel in dedicated plants but research into materials and catalysts is ongoing.

Aqueous Phase Reforming (APR)

The APR process catalytically converts biomass-derived oxygenates (such as sugars, sugar alcohols and polyols) into a hydrocarbon mixture that can be separated into a fuel slate including kerosene. Aviation kerosene produced via APR is in Phase 2 of the ASTM certification procedure (HDO-SAK). Unlike other reforming processes, APR operates in wet conditions which reduces the costs of dewatering certain feedstocks like sugars. However, it has low selectivity to liquid hydrocarbons (high gaseous yields) and short catalyst lifetime, making APR expensive today.

4.2.5 Summary of Pre-Qualification Stage routes

Several companies and organisations are engaging with ASTM but have not yet embarked on the certification process as shown in Figure 41. Some of these companies have already reached out to CAAFI and OEMs to begin the certification process.

ASTM D4054 pipeline		
Approach	Feedstock	Companies
ATJ Expansion	Alcohols (via sugars)	Swedish Biofuels*, Byogy
HDCJ (direct or co-processing)	Lignocellulose	Ensyn/Envergent, REC
Microbial conversion	Isobutene (via sugars)	Global Bioenergies*
HTL	Lignocellulose	Steeper, Genifuel, ...
Catalytic HTL	Lignocellulose	Licella, Muradel, QUT
Thermal Deoxyg.	Lipids	Forge Hydrocarbons*
SBI CGC PICFTR	Lipids - biodiesel	SBI Bioenergy / Shell
Acid Deconstruction	Lignocellulose	Mercurius
Bio-TCat (thermal catalytic)	Lignocellulose	Anellotech*
CCL	Lipids	
CHyP (syngas, non-FT)	Lignocellulose	
Hydrogenotrophic Conv.	CO ₂ / Producer Gas	
Cyanobacterial Prod.	CO ₂	
STG+ GTL	c1-c4 Gas / Syngas	
Ionic Liquid Decon.	Lignocellulose	
Metal Catalytic Conversion	Lignocellulose	
Enzymatic Conversion	Lignin	

24 October 2019 21

* Recent outreach to CAAFI R&D Team, ASCENT C.H. and/or OEMs



Figure 41: ASTM pipeline of routes yet to enter qualification⁷³

These pre-qualification stage routes have been grouped by type of feedstock and are discussed further in the sections below.

Hydrothermal Liquefaction (HTL)

HTL involves heating biomass and water at very high pressures to produce a bio-crude, with the near/super-critical water acting as a reactant and catalyst to depolymerise the biomass. The bio-crude produced can then be upgraded and while the higher molecular weight distribution makes HTL oil more suitable for diesel production, gasoline and jet are possible adding hydrocracking steps. HTL is well suited to very wet biomass feedstocks (sewage sludge, manure, micro and macro algae), as well as some lignocellulosic feedstocks. This route has not entered the ASTM certification process.

⁷³ <https://www.gti.energy/wp-content/uploads/2019/10/47-tcbiomass2019-Presentation-Steve-Csonka.pdf>

Hydroprocessed Depolymerized Cellulosic Jet (HDCJ)

Hydroprocessed Depolymerized Cellulosic Jet (HDCJ) is a class of processes that includes different routes converting lignocellulosic feedstocks into liquid fuels via thermochemical reactions. Most of these routes involve some form of pyrolysis.

Other routes

Global Bioenergies is pursuing a biological route to SAF production based on genetically modified bacteria converting sugars into isobutene producing a type of fuel similar to HFS-SIP. The technology maturity using conventional sugar feedstocks is at TRL 7-8, while the same processes based on cellulosic feedstocks is at TRL 5.

Another promising route to create renewable jet fuel is the Lipid-to-Hydrocarbon (LTH) technology. It converts waste fats and other organic oils into hydrocarbons. This conversion is performed through a two-stage process, hydrolysis followed by pyrolysis⁷⁴, and does not require any catalyst or hydrogen. Several developers are looking at these routes including Forge Hydrocarbons and SBI Bioenergy

MSW can be converted into jet fuel via gasification combined with methanol/DME synthesis and this is being investigated in the UK through the WasteWindWing (WWW) project. University College London are currently conducting a FEED study as the basis for a pilot plant to be built by 2022. ABSL are the expected gasification technology supplier⁷⁵.

Mercurius Biorefining, a US company, is developing a novel process which converts cellulosic biomass to renewable diesel, aviation and marine fuels. Their technology, “REnewable Acid-hydrolysis Condensation Hydrotreating” (REACH), creates an intermediate bio-crude product through the use of catalytic hydrolysis, which is then upgraded to transport fuel through commercial hydrotreating equipment⁷⁶.

Elsewhere, Anellotech’s patented Bio-TCat™ process produces 100% bio-based aromatic chemicals (i.e. benzene, toluene and xylene) which can be used as bio-marine fuel, or can be upgraded to make diesel or jet fuel blendstocks⁷⁷.

4.2.6 Current and future costs of biomass SAF routes

The cost of selected advanced biojet production is shown in Figure 42. The data used is mainly from an IRENA review of advanced biofuel routes, supplemented with additional sources where data was not available, and compared with other sources. All the routes are more expensive than fossil kerosene price (€600 /t pre-COVID⁷⁸). Producing jet from a first of a kind (FOAK) plant can cost between €740 and 6,500 /t depending on technology, plant scale and type of feedstock.

⁷⁴ Green Car Congress, October 2013 : <https://www.greencarcongress.com/2013/10/20131014-forge.html>

⁷⁵ IATA, 2019, “Sustainable Aviation Fuel Symposium”, <https://www.iata.org/contentassets/8dc7f9f4c38247ae8f007998295a37d5/safs2019-day1.pdf>

⁷⁶ Mercurius Biorefining website, accessed on 12/05/2020, <https://www.mercuriusbiofuels.com/Technology.html>

⁷⁷ Anellotech website, accessed on 12/05/2020, <https://www.anellotech.com/about-us>

⁷⁸ OPIS, 2019, OPIS Europe jet, diesel & gasoline report, <https://www.opisnet.com/wp-content/uploads/2019/01/europe-jet-report-sample.pdf>

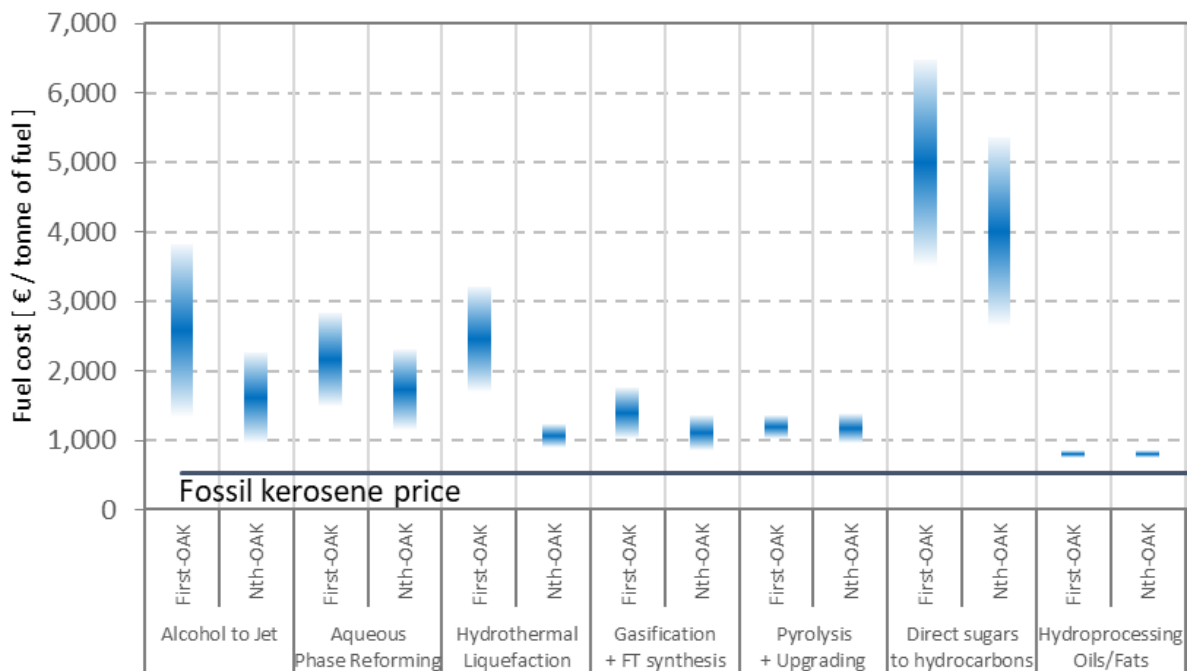

Figure 42: Fuel production cost for advanced biofuel routes. Source: multiple⁷⁹

Hydroprocessing of oils and fats is the most mature SAF technology, and is also currently the lowest cost route for SAF production. HEFA jet production costs can vary from 740 to 860 €/tonne where the lower end corresponds to a large scale plant and the upper end to a small scale plant. The most expensive route is Direct Sugars to Hydrocarbons reflecting the fact that transforming lignocellulosic biomass to sugars to intermediate products before upgrading remains a low efficiency route.

Despite the high cost of FOAK plants, technology learning can drive down capital cost and deliver operational learning. For several routes there are also large economies of scale. As a result, NOAK plants are in general less expensive than FOAK for all routes. In some cases, up to 60% reduction on production cost are expected when producing fuel from a NOAK plant. However, as Figure 42 shows, this cost reduction alone is not projected to make SAF cost-competitive with fossil kerosene. Either incentives for SAF or carbon taxes on fossil fuels are required to close this cost gap.

4.2.7 Cost of GHG saving of biomass SAF routes

The costs of GHG saving for the different SAF routes are shown in Figure 43. This is calculated as the cost difference between SAF and fossil jet divided by the SAF GHG emission savings. The overall picture for GHG saving cost is similar to the fuel production cost. The more mature technologies such as hydroprocessing of waste oils/fats and gasification of waste wood + FT are the most cost-effective decarbonisation options, while DSHC is significantly more expensive. The lowest GHG saving cost is €62/tCO₂e for hydroprocessing of waste oils/fats, while the highest is €1,960/tCO₂e for a FOAK DSHC

⁷⁹ IRENA, 2016, Innovation Outlook: Advanced Liquid Biofuels, <https://www.irena.org/publications/2016/Oct/Innovation-Outlook-Advanced-Liquid-Biofuels>; De Jong et al., 2015, The feasibility of short-term production..., <https://onlinelibrary.wiley.com/doi/abs/10.1002/bbb.1613>; NREL, 2016, Review of biojet fuel conversion technologies, <https://www.nrel.gov/docs/fy16osti/66291.pdf>; Malins, 2017, What role is there for electrofuel..., https://www.transportenvironment.org/sites/te/files/publications/2017_11_Cerology_study_What_role_electrofuels_final_0.pdf

case. However, it is important to note that the results are highly dependent on the feedstocks used, in particular for oil feedstocks.

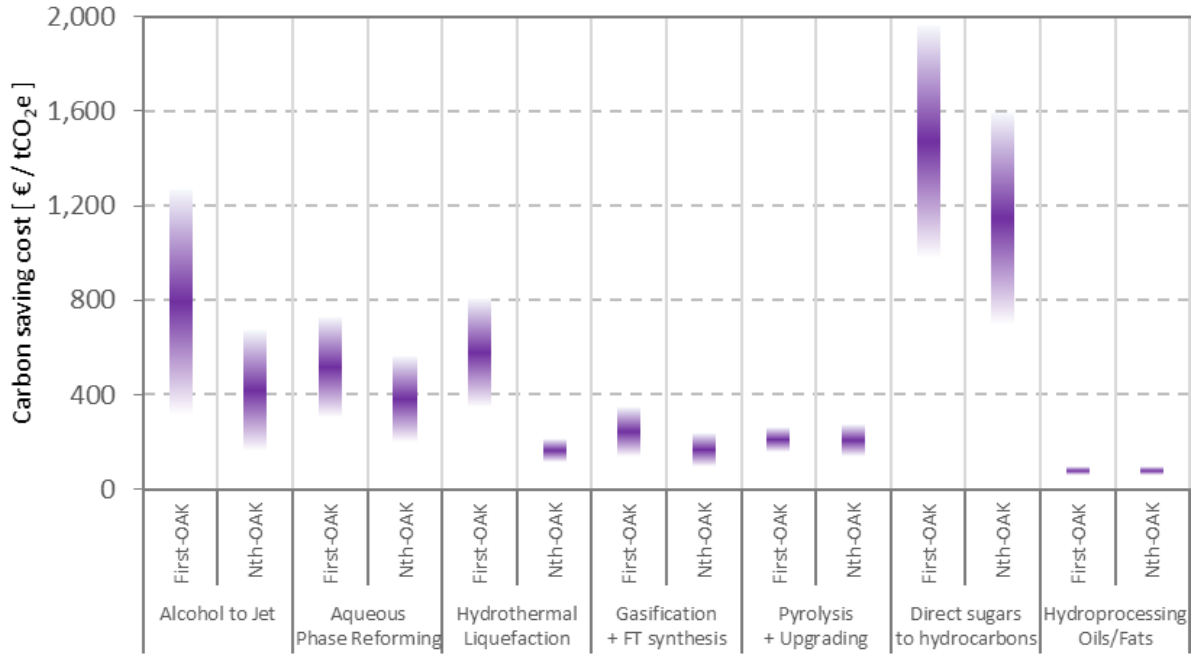

Figure 43: Carbon saving cost for advanced biofuel routes. Source: E4tech analysis based on multiple sources⁸⁰

⁸⁰ See Figure 42

5 Conclusions and implications

Current costs are high for green routes, whereas blue routes offer a lower cost alternative today

Our analysis shows that estimated costs of green synthetic jet fuel today (routes 1-6) would likely be very high, ranging from €4300 - 6800/tonne compared with pre-COVID fossil jet prices of around €600/tonne (assuming no carbon price is applied to fossil fuels). Costs for the methanol to jet and FT routes are very similar, since the majority of the production cost is hydrogen, and both routes have very similar hydrogen requirements. However, FT routes are ASTM approved and are more commercially mature than methanol to jet routes, which are yet to be ASTM certified.

Blue routes (routes 7-12, where blue hydrogen is combined with CO₂) currently have a cost advantage over green routes, due to the lower cost hydrogen, but the cost of blue synthetic kerosene at €1,500-2,300/tonne is still significantly higher than the price of conventional fossil jet (ignoring carbon pricing). Note that routes using waste CO (routes 13-15) could be more competitive, as discussed below.

The most costly routes are those involving DAC (routes 3, 6, 9 and 12), which is still to be commercialised, and requires significant energy inputs (which could be renewable as in DAC2, or supplied from power and gas grids as in DAC1). It is anticipated that the cost of DAC will fall considerably over time, reflecting learning rates, industrialisation of production and economies of scale. A faster ramp-up could accelerate these cost reductions.

Improving efficiencies and falling renewable power generation prices will see cost of green and blue routes converge by 2050

While blue synthetic kerosene is shown to be cheaper than green today, a combination of factors are expected to mean that costs converge over time. In 2050, the cost of green routes varies between €1,500 – 2,000/tonne while blue routes are in the range €1,300 – 1,700/tonne. The biggest factor is the expected fall in renewable electricity costs, although improving electrolyser efficiencies and falling capital costs across the process chain as scales increase also play a role. However, rising natural gas costs also contribute to the convergence in costs, by limiting blue route cost reductions. This convergence could facilitate a transition from blue to green routes over time, especially as the imposition of any carbon price on fossil fuels would tend to reduce the competitiveness of blue routes relative to green.

However, even after costs reductions, in 2050 the cost of synthetic kerosene remains significantly above the price of fossil jet today, implying that there would be continue to be a need to support synthetic kerosene routes, or to impose a carbon price on fossil fuels (assuming fossil jet prices were not to rise significantly over time).

The GHG savings from blue routes are modest

While synthetic kerosene produced from blue hydrogen + CO₂ is likely to be less costly than fuel produced from green hydrogen today, it delivers only limited GHG savings. If synthetic kerosene based on blue hydrogen + CO₂ is deemed to have acceptable GHG savings and is adopted as an interim solution, it will be important to consider how this can transition from blue to green hydrogen over time in order to achieve Net Zero targets. Alternatively, blue hydrogen + CO₂ routes could be deemed to have insufficient GHG savings, and so might not be supported in policy.

Synthetic kerosene from blue hydrogen + CO₂ from DAC may actually lead to an increase in GHG emissions depending on the assumptions made about the source of heat energy for the DAC process (in this analysis, assumed to be high temperature DAC fuelled by natural gas). Emissions from blue hydrogen + CO₂ routes (routes 7-12) are in the range 50-113 gCO₂e/MJ_{LHV} today falling to 49-81 gCO₂e/MJ_{LHV} in 2050 (the REDII transport fossil fuel benchmark is 94 gCO₂e/MJ_{LHV}), with the routes employing biogenic point source CO₂ being the most attractive. This compares with 1-22 gCO₂e/MJ_{LHV} for the green hydrogen + CO₂ routes (routes 1-6), although it is important to note the differences in underlying assumptions for DAC heating used in the blue and green routes. It should also be noted that biogenic point sources of CO₂ are likely to have limited availability and it is expected that the availability of fossil point sources of CO₂ will also decline over time due to policy.

GHG abatement costs are high initially but come into line with biofuel SAF routes over time

Both the green and blue synthetic routes have high GHG abatement costs today, reflecting the high costs of the green routes and the relatively poor GHG performance of the blue hydrogen + CO₂ routes. GHG abatement costs today are in the range €1,000 – 1,500/tCO₂e for green routes and €500 – 900/tCO₂e for blue (see Figure 26), which potentially supports the argument for allowing parallel development of blue and green routes. By 2050, green routes are expected to have lower abatement costs than blue routes, given falling costs. The CO based routes can have lower GHG abatement costs than the CO₂ routes, but only if the counterfactual use of the feedstock is unabated.

By 2050, synthetic kerosene is expected to have GHG abatement costs in a similar range to other forms of SAF such as advanced biofuel routes (see Figure 43).

Routes which utilise CO rather than CO₂ could provide a relatively low cost option and GHG emissions savings for sites where waste CO is available and unabated

The use of recycled waste fossil (or biogenic) CO in the production of synthetic kerosene via Fischer-Tropsch has potential, as the reverse water gas shift reaction required for CO₂ routes can be avoided, thereby resulting in lower costs and GHG emissions in 2030. Fuel costs of around €1,000 – 1,300/tonne in 2030 could be achievable with associated emissions highly dependent on the feedstock counterfactual used. For example, for the CO + WGS route in 2030, synthetic kerosene net lifecycle GHG emissions of -137 gCO₂e/MJ_{LHV} (i.e. a very large GHG saving) could be achieved if the feedstock counterfactual is unabated power generation (see Figure 24), but emissions would be 75 gCO₂e/MJ_{LHV} if the counterfactual is abated power generation (see Figure 25). The equivalent figures for CO + blue H₂ are 27 gCO₂e/MJ_{LHV} and 96 gCO₂e/MJ_{LHV}, and for the CO fermentation + ATJ route they are 32 gCO₂e/MJ_{LHV} and 190 gCO₂e/MJ_{LHV} respectively in 2030 (see Figures 22 and 23).

While there are a number of large point sources of recycled fossil CO available from industrial processes today, these may not be as geographically dispersed as CO₂ sources, potentially limiting the locations where this technology could be used. Fossil CO volumes are not limited today, but could be expected to reduce in availability over time as processes such as steel production decarbonise (e.g. switching from coking coal to technologies such as direct reduced iron). Since the FT process is indifferent to the source of syngas, CO based plants could transition from fossil CO to biogenic CO or from blue to green hydrogen, or with some further investment, transition to use of CO₂ (although this has not been analysed in this study).

Methanol based routes show similar cost and GHG performance to FT alternatives

A full set of methanol to jet routes was explored using either green or blue hydrogen and the complete range of CO₂ sources. The cost and GHG performance of these routes was almost identical to the results obtained for the FT routes. We conclude that any preference for one approach over the other would be driven by operational considerations rather than cost or carbon reduction potential. For example, methanol can be used as a fuel directly, as an input to other fuels including synthetic kerosene and as an intermediate input to products such as plastics; this market flexibility may be considered an advantage by some producers and may allow economies of scale to be realised.

Capacity scale-up could be rapid and make a contribution to the Netherlands' SAF objectives

The capacity build up modelling carried out for this study suggests that supply could reach 966 ktonnes/yr in Europe by 2030, and 28 Million tonnes/yr by 2050 if the majority of global activity were to remain in Europe. At global scale, the synthetic kerosene deployment could reach 1.3 Million tonnes/year in 2030 and 37 Million tonnes/year by 2050. For comparison, in the International Energy Agency's (IEA) B2DS scenario⁸¹, which aims to achieve global net-zero emissions by 2060, global SAF demand in 2060 reaches 150 Mtonnes/year corresponding to 70% of total aviation fuel demand. Synthetic kerosene routes could therefore materially contribute to overall SAF supplies.

A review of feedstock availability suggests that based on this capacity build up feedstocks potentials, at an aggregate level, are unlikely to restrict the rate at which capacity of any the routes considered can be rolled out. However, specific local constraints (e.g. on carbon sequestration or supply of renewable electricity) could affect the speed of roll out.

Whilst transitions or energy system modelling have not been examined in this study, an approach to developing synthetic kerosene that allows the use of both green and blue routes could potentially accelerate scaling up of the whole synthetic kerosene industry by introducing lower cost SAF earlier, with blue shifting to green hydrogen supplies over time – although blue routes may have to meet certain GHG savings thresholds to be deemed acceptable. Blue hydrogen production at scale would be consistent with the optimal scale for fuel synthesis, but is dependent on CCS infrastructure. Green routes, while currently significantly more expensive, do not necessarily rely on CCS infrastructure, will benefit from rapidly decreasing renewable power costs, and could contribute to balancing increasing renewable power on the grid.

Given asset lifetimes and the limited time available to 2050, there are also infrastructure lock-in risks from large-scale blue hydrogen deployment to consider (along with the associated upstream fossil gas supplies). If blue routes are to play only a transitional role given the modest GHG savings on offer, as noted previously, transition pathways need to be identified. Similarly, recycled fossil CO sources could be utilised for jet fuel production in the near to mid-term, but the need to avoid fossil emissions means that steel mills will increasingly decarbonise towards 2050, limiting the availability of these routes, and requiring switching of the jet synthesis plant to other feedstocks (either biogenic CO, or green hydrogen, or non-fossil CO₂ sources).

⁸¹ In the B2DS scenario "technology improvements and deployment are pushed to their maximum practicable limits across the energy system in order to achieve net-zero emissions by 2060 and to stay net zero or below thereafter, without requiring unforeseen technology breakthroughs or limiting economic growth".

Further possible areas of investigation include a more detailed analysis of Net Zero compatible pathways and assessment of alternative electrolysis routes

A valuable area of further investigation would be around Net Zero compatible transition pathways, and how quickly the sector will have to transition from the use of point fossil sources of CO₂ and/or blue hydrogen to routes that use DAC or biogenic CO₂ in conjunction with green hydrogen. This should include consideration of the relative merits of different routes, including both FT and methanol options. A more structured pathway analysis including timeframes, phase out/phase in transitions and total cumulative GHG savings would be useful in developing a roadmap for the development of synthetic kerosene.

A number of additional technologies are under development or consideration which have not been considered in this analysis, e.g. high temperature solid oxide electrolysis and CO₂ co-electrolysis, and these could be explored in more detail. Some of these technologies offer promise, e.g. in terms of improved efficiency, so support for their research and development could help them to achieve commercial readiness more quickly.

Appendix A : Methodology for assessment of synthetic kerosene production potential

Short term capacity development to 2030

The bottom-up ramp up model is used to estimate the synthetic kerosene capacity development to 2030 at both European and global scale. It represents the average scale up potential of the synthetic kerosene supply and is based on information gathered on companies currently developing synthetic kerosene technologies and the plants they operate or new plants they have announced.

The likely future deployment of each route is then assessed based on the following key factors that influence how far and how fast a route can progress:

- **Project timeline:** how long it takes to build each plant.
- **Lifetime:** How many years each plant operates for.
- **Plant capacity:** How large each plant is.
- **Utilisation rate:** How many hours per year a plant operates for.
- **Initiation rate:** How many commercial projects can be started each year?
- **Launch points:** How soon after a previous project starts is it is feasible for the next project to start.
- **Success rate:** How many of these plants and developers might fail/be unsuccessful.
- **Number of developers** independently starting projects.

Given the large degree of uncertainty in how these factors will evolve and vary to 2030, two scenarios reflecting slow and fast industry growth have been considered. The slow and fast growth scenarios differ in terms of the **initiation rate**, the **launch-point** and the **success rate**. The two scenarios are developed both globally and for the EU region.

Supply scale-up	Geography	
	Fast growth Europe	Fast growth Global
	Slow growth Europe	Slow growth Global

Figure 44: Summary of sustainable scale up scenarios.

Project timelines

The development timeline defines how long it would take to go through all the project phases until from project inception to a fully operational plant. This includes Project development & financing (PD), Construction (CO), Commissioning & ramp-up (CM) phases. For each technology type (biological, thermochemical and chemical) and for each stage of plant scale-up (pilot, demonstration, 1st commercial, 2nd commercial and Nth commercial) an average development timeline is applied, as illustrated in Figure 45.

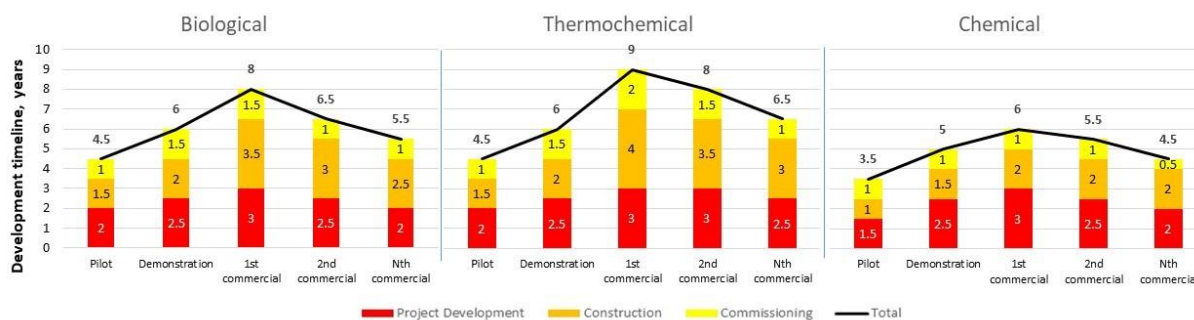

Figure 45: Illustrative development timeline assumptions

Small pilot and demo plants are relatively quick to design, build and commission, whereas 1st commercial plants typically take the longest number of years to become fully operational. For subsequent commercial plants (2nd and Nth commercial plants) the development timeline is assumed to be quicker, due to developer learning and replication of technical plans, contracts etc.

Thermochemical routes are the most capital intensive and will typically have longer timelines. Chemical routes are the least capital intensive with shorter timelines. Biological routes generally lie somewhere in between.

Lifetime of plants

The following assumptions were made concerning plant lifetimes:

- Pilot plant = 3 years
- Demonstration plant = 5 years
- Commercial plant = 28 years

By taking this approach, any pilot and demo plants built early in the timespan modelled do not contribute to the total production capacities at the end of the period. The short lifetime of pilot and demonstration plants reflects the fact that they are often loss-making facilities. Generally, developers only operate these plants until gaining enough valuable test data and experience, to finance future plants. Given that the nominal capacity of pilot and demo scale plants are very small compared to the commercial facilities, the length of their lifetimes has limited impact on the overall ramp-up results.

Generic plant output

The 1st commercial and 2nd commercial plant nominal capacities were based on the size of plants already constructed or planned by companies. For Nth commercial plants, it was assumed that each technology route converged to using an average output fuel capacity per year figure for all the Nth commercial plants within that route. If the nominal capacity of any plants at earlier maturity stage was unknown, a percentage of the Nth commercial plant nominal capacity was assumed (Table 13).

Table 12: Theoretical nameplate capacities of commercial plants assumed in modelling

Conversion route	million litres/yr	PJ/yr
CO fermentation: Fermentation of CO to ethanol	139	2.9
Alcohol to jet: Ethanol to jet synthesis	183	6.3
CO + FT: CO + Fischer-Tropsch to jet synthesis	519	17.8
Green FT: Renewable hydrogen + CO ₂ to Fischer-Tropsch jet synthesis	111	3.8
Green methanol: Renewable hydrogen + CO ₂ to methanol synthesis	195	3.1
Blue methanol: Blue hydrogen + CO ₂ to methanol synthesis	467	7.4
Methanol-to-Jet: Green or blue methanol to jet synthesis	163	5.8

The assumptions around the capacity of Nth commercial plants are provided in Table 13. These are not assumed to vary by scenario, given the economically viable plant scales are not particularly dependent on the wider industry development – rather they depend on capital costs, operating costs and efficiencies, trading off against feedstock prices and local availability near plants (or imports). Within the considered timespan, there will not be multiple rounds of Nth commercial plants built, so these assumptions will apply to all modelled Nth commercial plants.

Table 13: Nameplate capacities assumptions by plant maturity, in percentage of Nth commercial plant

Nominal capacity assumption	%
Pilot plant	1
Demonstration plant	10
1 st Commercial plant	80
2 nd Commercial plant	80

Availability of plants

All plants across all routes were assumed to run at 90% utilisation once successfully constructed and commissioned. This means that the actual annual fuel production is slightly below the nameplate capacities.

Number of developers

The number of developers is a key determinant of future deployment of a specific technology. Each developer is expected to take their technology to commercial scale (subject to any failure rates) and start initiating new commercial projects (either under an owner operator or licensing model).

Table 14 outlines the number of technology developers globally for each conversion route as of today. These were not assumed to vary by scenario or over time, as this number is an actual, current number of developers within each route. This is based on the working principle to include only developers which have at least a pilot plant. Lab-scale facilities – often in research institute – are

excluded. The ramp up model does not consider the potential entry of new developers or the termination of activity of currently active developers.

Table 14: Number of technology developers worldwide

Conversion route	
CO fermentation: Fermentation of CO to ethanol	1
Alcohol to jet: Ethanol to jet synthesis	5
CO + FT: CO + Fischer-Tropsch to jet synthesis	1
Green FT: Renewable hydrogen + CO ₂ to Fischer-Tropsch to jet synthesis	8
Blue FT: Blue hydrogen + CO ₂ to Fischer-Tropsch to jet synthesis	0
Green methanol: Renewable hydrogen + CO ₂ to methanol synthesis	24
Blue methanol: Blue hydrogen + CO ₂ to methanol synthesis	0
Methanol-to-Jet: Green or blue methanol to jet synthesis	1

Initiation rate

The initiation rate is the number of Nth commercial projects that start construction per year (globally), per developer. The main drivers underpinning the initiation rate are the attractiveness of licensing the technology, which depends on economics, constraints (such as feedstocks), and the capacity of each Nth commercial plant.

The initiation rates assumed are summarised in Table 15.

Table 15: Number of Nth commercial projects started each year, by developer for the considered conversion routes

Conversion route	Slow Growth	Fast Growth
	#/year	#/year
	1	2

Launch-points

The launch points define when the next maturity stage (project) is most likely to start (

Table 16). These were assumed to vary according to the technology stage, and between scenarios, but not vary significantly between technologies, reflecting the fact that investors are likely to require a similar number of years of operational evidence before taking larger investment decisions, independent of the specific technology.

Table 16: Launch point assumptions for each maturity stage

Maturity stage	Rules	Slow Growth (years)	Fast Growth (years)
Pilot	Only actual or announced pilot plants will be featured		

Maturity stage	Rules	Slow Growth (years)	Fast Growth (years)
Demonstration	Any actual or announced demo projects will be featured. If no plans, demo project development assumed to begin # (see right) years after the start of pilot operations	1	0.5
1 st commercial	Any actual or announced projects will be featured. If no plans, 1 st commercial plant construction assumed to begin # (see right) years after the start of demonstration operations. Investors often require ~10,000hrs of operational data before investing in a 1 st commercial plant	3	2
2 nd commercial	Any actual or announced projects will be featured. If no plans, 2 nd commercial plant construction assumed to begin # (see right) years after the start of 1 st commercial plant operations	3	2
N th commercial	Nth commercial construction begins # (see right) years after the start of 2 nd commercial plant construction. Several plants can be initiated simultaneously (see initiation rate slide), with the same number of new plants initiated the next year, and the next year, etc.	2	1.5

Success rate

Projects and developers may not be successful. For this reason a % success rate was used to define the expectation of any particular project being successful from inception to operation (Figure 46 and Figure 47).

Compounded success rate if a developer already has an operating plant at X technology stage today

Future technology stage	Individual plant success rate	Pilot	Demo	1 st com	2 nd com	N th com
Pilot	50%	100%	100%	100%	100%	100%
Demonstration	60%	60%	100%	100%	100%	100%
1 st commercial	70%	42%	70%	100%	100%	100%
2 nd commercial	80%	34%	56%	80%	100%	100%
N th commercial	90%	30%	50%	72%	90%	100%

Figure 46: Success rate assumptions by technology state, in the Slow Growth

Compounded success rate if a developer already has an operating plant at X technology stage today

Future technology stage	Individual plant success rate	Pilot	Demo	1 st com	2 nd com	N th com
Pilot	75%	100%	100%	100%	100%	100%
Demonstration	80%	80%	100%	100%	100%	100%
1 st commercial	85%	68%	85%	100%	100%	100%
2 nd commercial	90%	61%	77%	90%	100%	100%
N th commercial	95%	58%	73%	86%	95%	100%

Figure 47: Success rate assumptions by technology state, in the Fast Growth

The **compounded success rates**, on the right-hand side of the tables, accounts for the impact of the success of preceding plants on the success rate of a forecasted plant. For example, if a developer is currently operating a demonstration plant its individual success will have an impact on the likelihood of success of a future 1st commercial plant. The compounded success rate % is a factor employed to account for the interdependency of success rates between plants of different maturity scales of the same developer. This factor is applied to individual plant production outputs to calculate the likely average fuel production.

Validation of input assumptions and results

E4tech have previously validated many of the assumptions in this model with fuel producers, and in addition we reached out to developers of Alcohol to jet and Fischer-Tropsch technology to validate specifically the kerosene production slate assumed in this model.

Product slate

Synthetic kerosene production produces a range of hydrocarbons including jet and naphtha, as well as other fuel types. The final distribution of hydrocarbon products is affected by many different factors including commercial and technical factors, such as tailoring of specific conditions within the different processing steps. As a result, for each technology an ‘aviation optimised’ scenario is given, which favours the production of the kerosene fraction. This translates into a product slate factor which is applied to the capacity output obtained for each route.

The percentage of jet fuel (as a percentage of total fuel output from the plant) is shown in Table 17. Note that an average kerosene fraction of 55% was assumed for the Fischer-Tropsch route. Given strong policy support for the SAF market, this fraction could be much higher (nearer 80%), if process conditions, reactor design and catalyst performance are optimised. However, uncertainty around transport policy and the relative support incentives between road and aviation markets is likely to prevail over the next decade, so for this reason choosing a more conservative kerosene fraction appears to be more reasonable.

Table 17: High kerosene slate

Route	Jet % of fuel outputs
Alcohol to jet: Ethanol to jet synthesis	90%

CO + FT: CO + Fischer-Tropsch to jet synthesis: ⁸²	55%
Green FT: Renewable hydrogen + CO ₂ to Fischer-Tropsch ⁸³	55%
Methanol-to-Jet: Green or blue methanol to jet synthesis	90%

The conversion routes Methanol-to-Jet (routes 4-6, 10-12) and CO fermentation to jet (route 13) produce synthetic kerosene via the intermediates of methanol and ethanol respectively. For modelling purposes, the production of the intermediate alcohols was modelled separately from the jet fuel synthesis. This reflects the trends observed amongst technology developers. For example, a power-to-methanol producer may choose to sell the e-methanol into various markets such as maritime or aviation fuels. As such, these intermediate routes are treated as low carbon feedstocks needed to produce jet fuel via the Methanol-to-Jet and the alcohol to jet routes.

Table 18: Conversion routes of “intermediates” treated as feedstock availability for synthetic kerosene synthesis

Route
Fermentation of CO to ethanol
Green hydrogen + CO ₂ to methanol
Blue hydrogen + CO ₂ to methanol

Long term outlook to 2050

It is likely that the landscape of the aviation industry and the policy framework around it will have changed considerably by 2030. Current early-stage synthetic kerosene technologies could significantly mature within the next 10 years, and new technologies may be developed. Furthermore, new developers or companies are likely to enter the industry. Additionally, policy mechanisms should boost the uptake of synthetic kerosene technologies to decarbonise the aviation sector. The validity of assumptions made for the bottom-up approach to 2030 might therefore not hold over the longer time horizon to 2050. As technologies mature, and policy support increases, higher growth rates of synthetic kerosene supply capacity could be expected. The longer-term picture is generally more uncertain and reflects the development of the whole aviation industry, the evolution of which is dependent on many factors out of the scope of this study, such as competition between sectors and policy support.

An alternative “top-down” approach was therefore adopted to provide some insights on what the picture might look like in Europe and globally in 2050. Capacity development for the period 2030 – 2050 is extrapolated based on a fixed annual growth rate for each of the fuel routes examined, with the baseline being the capacity levels estimated in the short-term analysis.

The same growth rate was adopted for the extrapolation of synthetic kerosene production capacity across both Europe and globally. Today, Europe dominates R&D activities in the aviation fuel industry. However, given the global nature of the sector it is expected that future large-scale developments of

⁸² ICCT (2019) https://theicct.org/sites/default/files/publications/Alternative_jet_fuels_cost_EU_20190320.pdf, Note that much higher proportions of jet are achievable via that FT synthesis but this different slate would alter the economics of the process and the figures used in the techno-economic analysis.

⁸³ idem

synthetic kerosene plants are not bound to one specific geography. In summary, a constant growth rate is applied for the scale up of each synthetic kerosene route from 2030 onwards.

The growth rate applied differs between the different type of routes, i.e. steel mill waste gas based routes, power-to-liquids based routes and blue hydrogen based routes. The selected growth rates are and reasoning for their selection is summarised in Table 19.

Table 19: Summary of selected growth rates for synthetic kerosene scale up post 2030

Route	CAGR	Growth rate basis	Reasoning
Steel mill waste to ethanol to jet	15%	Global HVO production between 2019 and 2025 ⁸⁴	Assuming the steel mill waste fermentation route reaches TRL 9 in 2030, the growth will be affected by market demand and feedstock availability. This routes shares similarities with the HVO conversion route as in both cases the build-up of sales into the fuels market is affected by long term feedstock constraints.
Power-to-Liquids routes	21%	Average of global PV industry growth ⁸⁵ (21%) between 2015 and 2019. and global offshore wind industry ⁸⁶ (20%) in 2018	The large-scale supply of renewable power is seen as the limiting factor on the power-to-liquids scale-up, especially given the growing competition for renewable power between different end sectors (heating, buildings, transport). The proxy is based on the average growth rates of the PV and offshore wind industries. While the offshore market grew by 30% between 2010 and 2018 ⁸⁷ , the latest growth rate in 2019 is assumed to be more representative of the long term.
Blue routes	10%	Based on global CO2 capture and storage capacity ⁸⁸	The supply of natural gas is likely to be sufficient, however, carbon capture and storage capacity is expected to be the limiting factor in the scale up of the blue kerosene routes. A recent study by Zahasky and Krevor develops scenarios for global geologic carbon storage requirements with growth rates ranging 8.6% to 12.1%. The CAGR of the global CO ₂ storage capacity is therefore a good indication of how blue hydrogen could become available for kerosene supply.

While the deployment rates for analogous industries is considered to be a reasonable proxy for growth in synthetic kerosene, it is important to bear in mind that other geographical, temporal and economic aspects will be important. For this reason, applying “proxy growth” factors from analogous industries to estimate the ramp up of synthetic kerosene from 2030 onwards, means assuming a similar context, i.e. a highly-favourable economic and regulatory context which may not exist in support of aviation fuel in 2030.

Location of synthetic kerosene plants

The ramp up model estimates the capacity scale up of synthetic kerosene, based on announced and already operational plants. The location of these plants in the model matches the location announced by the technology developer. The assumptions described above are applied to estimate “speculative new plants” for each technology developer. Once a technology developer operates plants at commercial scale, the model assumes new hypothetical plant locations which alternate between Europe and Rest of the world. As described above, beyond 2030, a constant growth rate is

⁸⁴ IEA, Available at: <https://www.iea.org/reports/renewables-2020/transport-biofuels>

⁸⁵ IEA, Available at: <https://www.iea.org/reports/solar-pv>

⁸⁶ IEA, Available at: <https://www.iea.org/reports/offshore-wind>

⁸⁷ IEA, Available at: <https://www.iea.org/reports/offshore-wind-outlook-2019>

⁸⁸ Zahasky C, Krevor S. Global geologic carbon storage requirements of climate change mitigation scenarios. Energy & Environmental Science. 2020;13(6):1561-1567.

applied to the 2030 baseline. Since the majority of announced and operational synthetic kerosene plants will be located in Europe in the short term (2030), the long-term outlook will maintain a similar split.

Ramp up results

Note that in the following charts, the “CO to Jet” results include the CO fermentation to jet and the CO + Fischer-Tropsch synthesis routes.

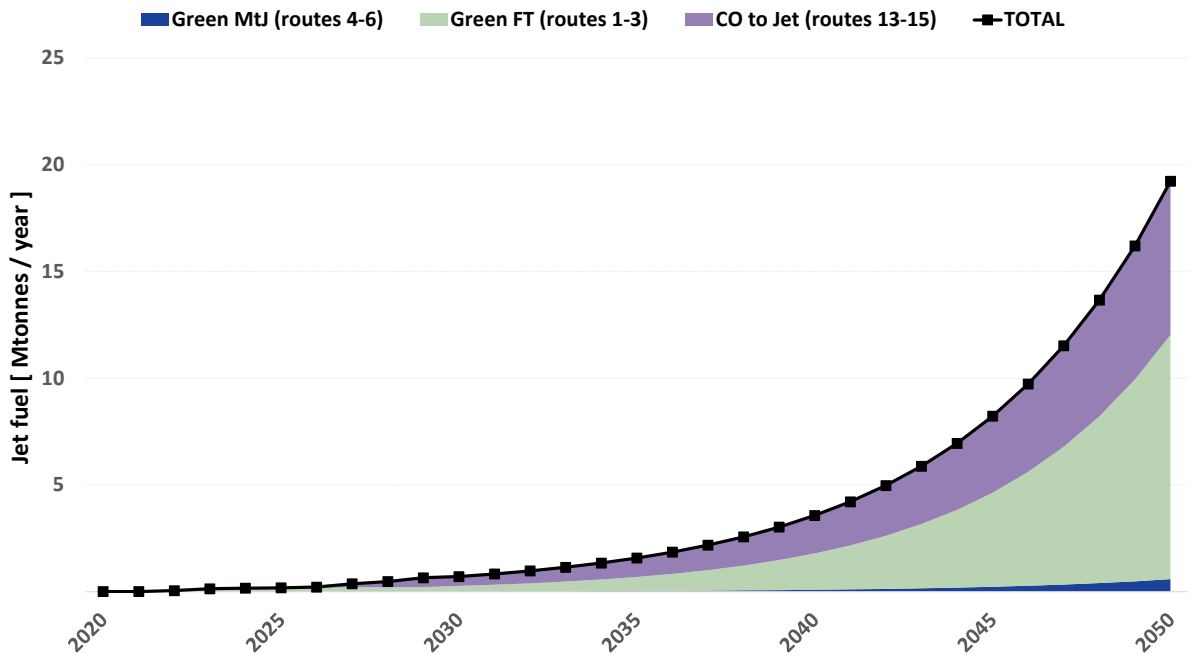

Figure 48: Route breakdown of synthetic kerosene in Europe to 2050 under the slow growth scenario

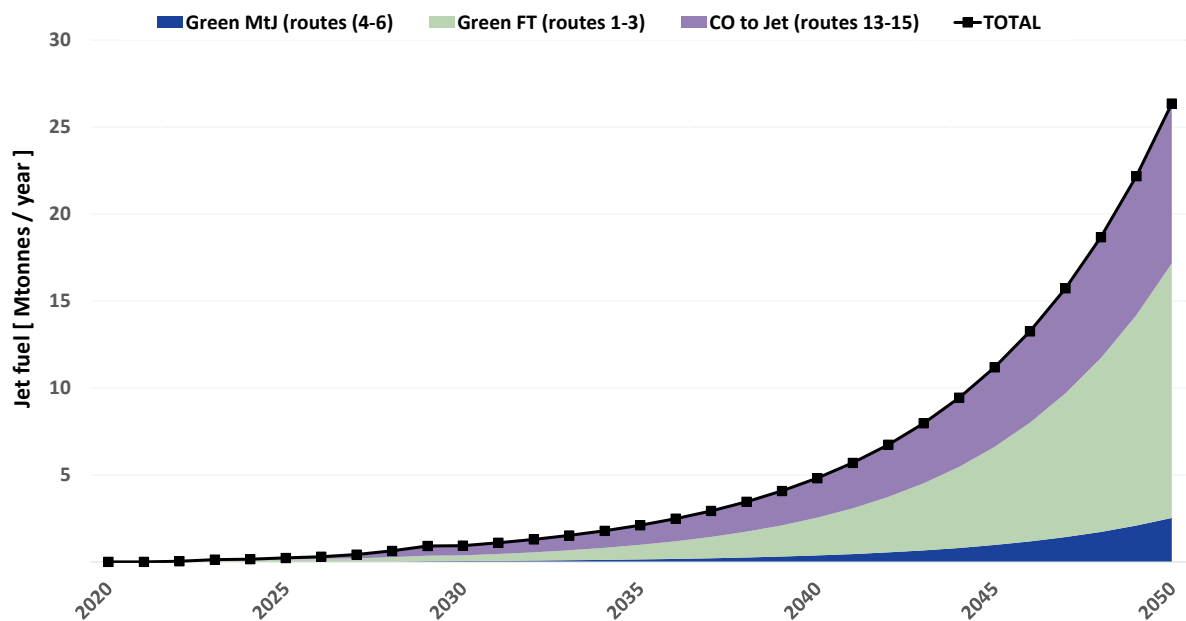

Figure 49: Route breakdown of synthetic kerosene in Europe to 2050 under the fast growth scenario

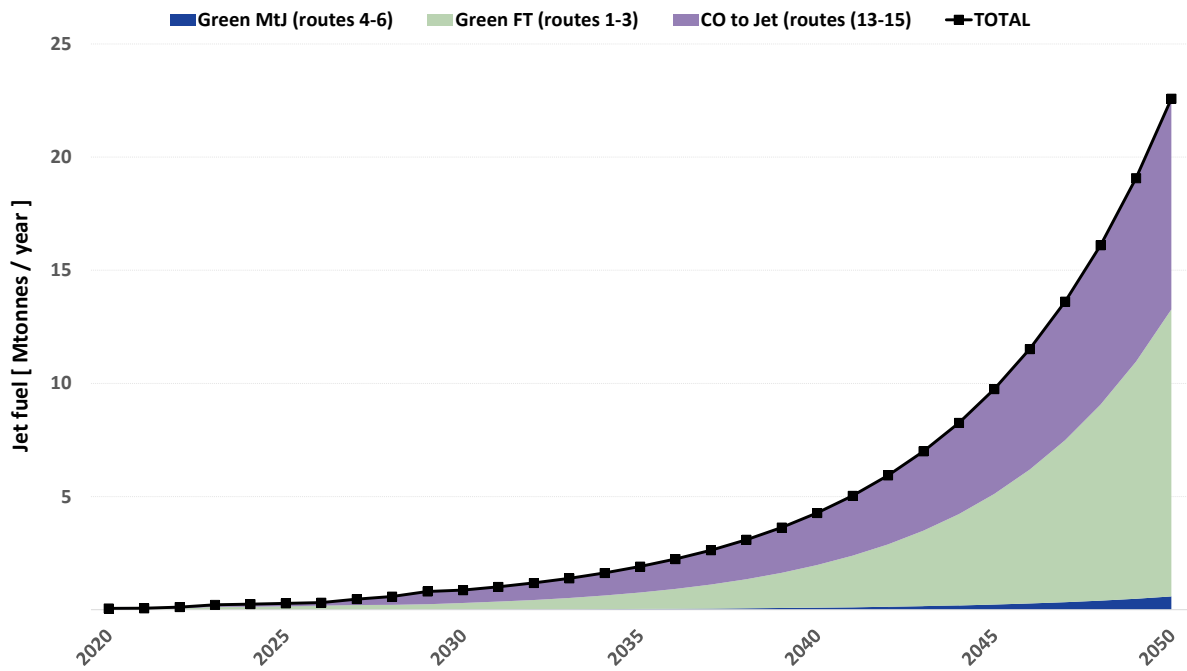

Figure 50: Route breakdown of global synthetic kerosene to 2050 under the slow growth scenario

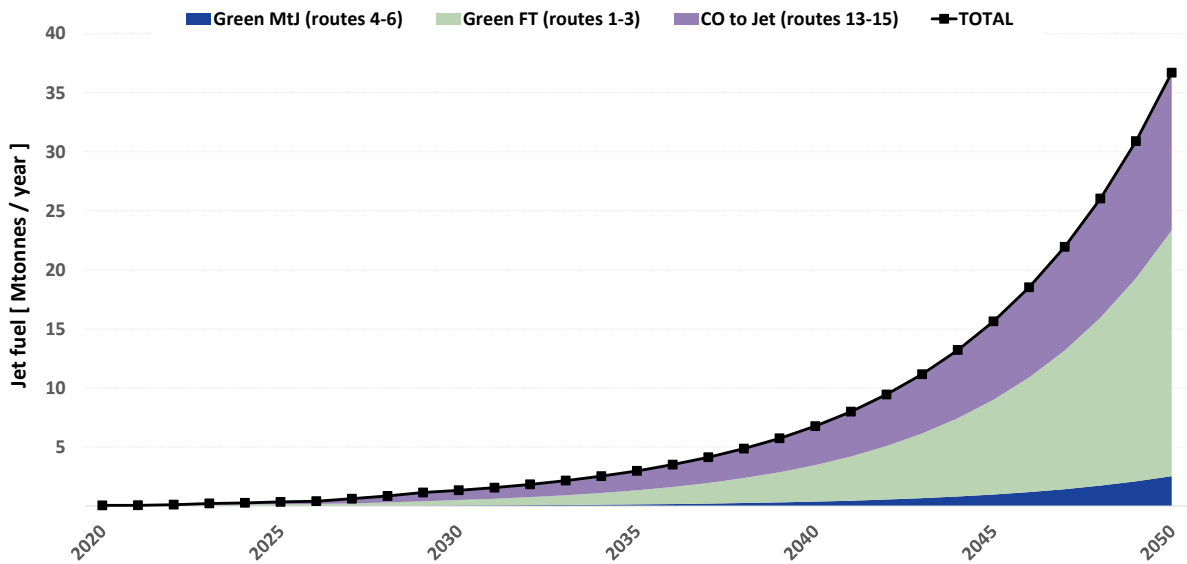

Figure 51: Route breakdown of global synthetic kerosene to 2050 under the fast growth scenario

Appendix B : Techno-economic modelling

Model description

The modules constituting the routes are sized according to the final product throughput which is estimated based on examples of existing or planned projects.

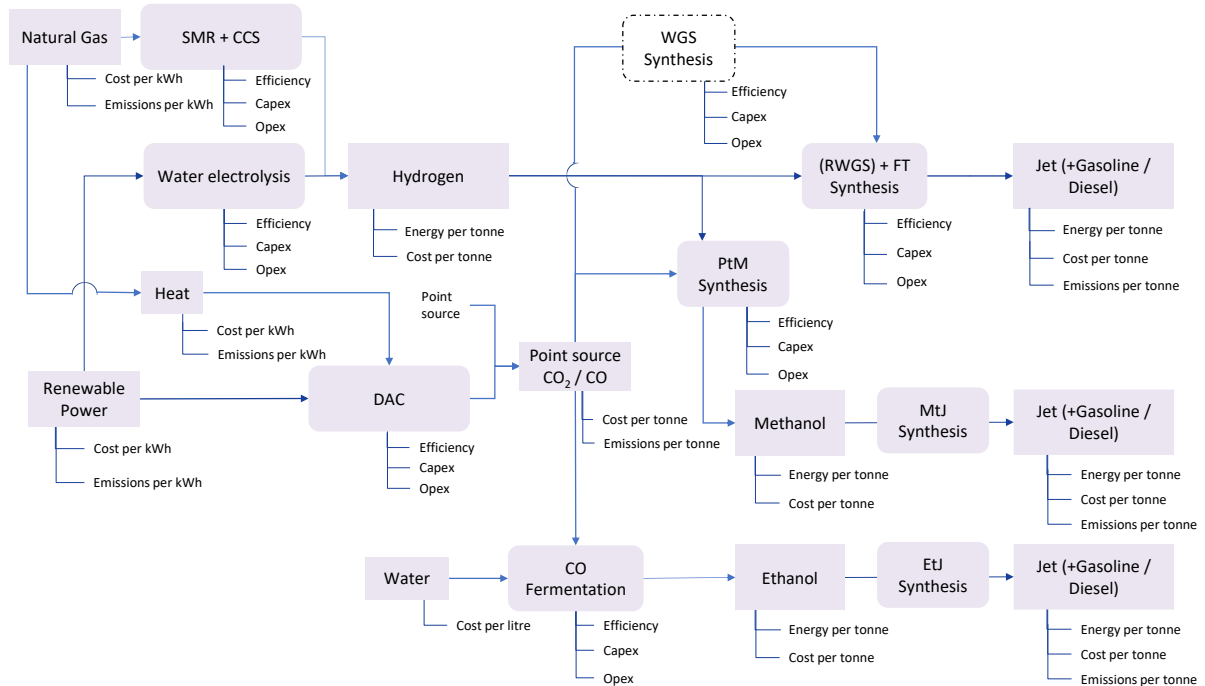

Figure 52 Techno-economic model structure

Data for each module (except for the CO from steel mill routes) is based on published literature and, wherever necessary, absolute quantities (e.g. energy requirement in kWh) were normalised on product output in order to derive relative quantities (e.g. specific energy requirement in kWh/kg). Data for the steel mill routes are from the developers themselves and have not been peer reviewed/validated.

The levelised cost of production of the products has been calculated including the following costs: capital expenses for main equipment components (e.g. reactors), maintenance, stack replacements, power utilities, heat utilities, CO₂ and indirect plant costs. Capital expenses (except for stack replacement costs) and indirect plant costs are assumed to be incurred before the commissioning of the plant. All other expenses occur with annual frequency (except for stack replacement which is concentrated in specific years) and are subjected to discounting. An additional module accounting for the downstream impacts of the fuel e.g. cost and GHG emissions associated with transporting the fuel from the production site to the airport has been included for each chain.

The energy efficiency of the route is calculated as the ratio between the energy content of the product and the external energy input to the process. Among the external inputs there are the power supply to the electrolyser, power supply to auxiliaries of the various modules such as pumps and fans and thermal energy required by the process that cannot be recovered internally.

$$\text{Pathway Energy Efficiency} = \frac{\text{Energy content of product (LHV)}}{\text{Power supply} + \text{External heat supply}} \left[\% \frac{\text{MJ}_{\text{LHV}}}{\text{MJ}_{\text{input}}} \right]$$

The GHG emissions associated with each process, are evaluated considering only the main contributors and neglecting, for example, indirect emissions of raw materials, water, construction, etc. The exception is the CaCO₃ absorbent used in DAC processes for which CO₂ emissions have been included. The main contributors to GHG emissions are: electric power supply, external thermal power supply (which can be in different forms depending on the scenario selected) and emissions associated with the CO₂ capture process. All emissions (upstream + combustion factors) relating to natural gas used in DAC or marginal natural gas used for point source CO₂ capture is counted due to release back to atmosphere when burnt as jet. The fossil CO₂ used in fuel synthesis is considered to have zero emissions, i.e. assuming that it is waste CO₂ that would have been emitted into the atmosphere anyway, if a power-to-liquid plant was not using it.

Integration of different parts of a process is often key to achieving high levels of material and energy efficiency. It would be possible e.g. to feed heat back to the CO₂ capture if the DAC and FT plant were located co-located geographically and this could increase efficiency. In this model, all the components (electrolyser, SMR, DAC, point source, FT plant, methanol route) are considered independently, so no heat integration is included.

The model has been built with the option of exploring different scenarios with regard to the type of electricity supply, external heat supply and CO₂ origin, with implications on the levelised cost of production and GHG emissions. The reference values were chosen to best reflect those available now and in the future in the Netherlands, but the model offers a selection of cases to be chosen to explore their impact on results.

Table 20 Table of assumptions

Power	2020	2030	2050	Units
Dutch grid electricity cost	41	51	51	€/MWh
Dutch grid electricity GHG	0.4	0.1	0.0	kgCO ₂ e/kWh
Renewable electricity cost ⁸⁹	73	45	26	€/MWh
Renewable electricity emissions	0	0	0	kgCO ₂ e/kWh
Heat				
Dutch NG cost	16.5	23.7	23.7	€/MWh
Dutch NG combustion emissions	0.202	0.202	0.202	kgCO ₂ e/kWh
Dutch NG upstream emissions ⁹⁰	0.032	0.032	0.032	kgCO ₂ e/kWh
Green H ₂ GHG	0	0	0	kgCO ₂ e/kWh
Synfuel plant capacity				
CO ₂ routes	5,000	30,000	100,000	tonnes/yr
CO fermentation + ETJ route	30,000	92,250	315,000	tonnes/yr
CO + FT routes	n/a	505,000	505,000	tonnes/yr

⁸⁹ <https://www.theccc.org.uk/publication/sixth-carbon-budget/> CCC Sixth Carbon Budget Supporting information, charts and data in the report

⁹⁰ <https://ec.europa.eu/irc/en/publication/eur-scientific-and-technical-research-reports/jec-well-tank-report-v5> GMCG1 pathway, up to point of compression and dispensing

(both WGS and blue H2)				
------------------------	--	--	--	--

The renewable energy costs used are generation cost projections for wind/solar and do not include grid balancing/peaking plant and storage costs. The data is sourced from the CCC UK data 6th carbon budget⁹¹ and converted using the current exchange rate.

FT synthesis step

The FT synthesis step combines the hydrogen produced and CO₂ captured in the RWGS to produce a dry syngas which is then fed into the FT reactor. The data for FT synthesis, including data for the RWGS required in the standard electrolysis routes, are from Marchese et al.⁹², using their Case A, 90% recirculation, low pressure scenario. The FT synthesis process is exothermic and so could benefit from heat integration in the future.

- FT reactor has excess heat available at a constant 228°C
- Exhaust gas has excess heat available from 1000°C to 50°C
- Syngas cooling has excess heat available from 800°C to 25°C

Heat is required for the RWGS, and only a portion of this heat requirement could be met from excess heat from the FT synthesis. This is because the amount of recycled heat from FT synthesis to RWGS is limited by the amount of high temperature heat available. Therefore, the RWGS would still require an external heat input, although this could potentially be met by electrical heating in the future. The hydrocracker modelled was taken from Hannula et al.⁹³ Plant scaling costs were taken from Brynolf et al.⁹⁴. The modelled chain includes RWGS combined with an FT reactor for this route but an alternative scenario could see syngas produced by co-electrolysis of H₂O and CO₂ instead of via the RWGS reaction.

Heat

Thermal energy can be provided in different ways (e.g. electricity, natural gas, hydrogen, waste heat from other industries) with implications for both associated cost and GHG emissions. In the cases where renewable hydrogen has been used as a heat source, it has been assumed that this has been bought in and so the LHV of hydrogen has been used in efficiency calculations rather than the renewable electricity from which the synthesis of this hydrogen originated.

If heat is provided by natural gas, both scope 1 (carbon content of the natural gas) and scope 2 emissions have been accounted for. While the gas grid is likely to slowly decarbonise over time with increasing substitution of renewable methane and hydrogen, the natural gas modelled in this study is not assumed to decarbonise with time, as projections to 2050 were not available, and new demands from synthetic kerosene are assumed to be met by fossil natural gas given the constrained availability of higher cost low-carbon gas sources.

⁹¹ <https://www.theccc.org.uk/publication/sixth-carbon-budget/> CCC Sixth Carbon Budget Supporting information, charts and data in the report

⁹² Marchese et al. (2020) *Energy performance of Power-to-Liquid applications integrating biogas upgrading, reverse water gas shift, solid oxide electrolysis and Fischer-Tropsch technologies*. Available at:

<https://www.sciencedirect.com/science/article/pii/S2590174520300131?via%3Dihub>

⁹³ 2013, "Liquid transportation fuels via large-scale fluidised-bed gasification of lignocellulosic biomass".

⁹⁴ Brynolf et al., 2018, "Electrofuels for the transport sector: A review of production costs"

If heat is provided by renewable hydrogen or renewable electricity, it has zero associated CO₂ emissions.

General modelling assumptions

Other important parameters affecting the results of the analysis are:

- **Capex annualization discount rate.** This is the rate at which future expense are discounted to present value and is equal to the WACC of the project. In this study a typical value of 7% has been chosen, chosen based on E4tech analysis.
- **Plant lifetime.** Assumed to be 25 years unless stated otherwise.
- **Yearly plant utilisation.** Plants require yearly maintenance during which the plant needs to be shut down. For this reason, a yearly utilisation factor of 85% (~7450hrs) has been used, which is applied to the nameplate throughput of the plant to obtain the actual annual production.
- **Indirect plant costs.** These represent investment costs associated to the realisation of the whole plant including for example engineering and construction, fees and project contingency cost. Indirect plant costs are estimated in an aggregate way as a proportion of the plant equipment cost. Based on Brynolf et al. (2018)⁹⁵ these costs are estimated to be 100% of plant equipment cost.
- For the steel mill CO with WGS route, there is no **heat integration** in the 2030 plant so a heat source must be used to generate the steam, but integration with waste heat or electrification are possible ways the plant could be improved in the future. However, the FT reactor does produce a lot of water, which has been recycled within the system boundary as the water source for the steam generation.
- **Water** - this depends on location but in most cases costs are likely to be negligible compared to other costs given the low water consumption of electrolysis⁹⁶ and low prices of water (~ €1/m³ for industrial users). For this reason, water costs (and GHG emissions) have not been included in this study.
- **Transport** from the production plant to the airport refuelling site uses a value of 0.65 gCO₂e/MJ of jet taken from the CCC 6th Carbon budget and the "transport to airport" cost estimate is from an LBST study⁹⁷
- **CCS costs** - The cost of carbon capture is included in the costs of the generation technologies themselves; dehydration and compression of the captured CO₂ are included within the SMR plant boundary. However, **downstream transport and storage costs for this CO₂** have been added separately for both blue H₂ production and the CO + WGS route. A value of €17/tCO₂ was used, taken from the CCC 6th Carbon budget for North Sea storage.
- **GHG abatement** - a fossil jet price of \$600 has been used with emissions of 4136 kgCO₂ per tonne jet fuel.
- **Data for the steel mill routes** are from the developers themselves and have not been built up in the same manner as for the other routes but where possible common input data has been used. The assumptions have been validated as far as possible against other peer reviewed data sources.

⁹⁵ Brynolf et al., 2018, "Electrofuels for the transport sector: A review of production costs"

⁹⁶ Water consumption for PEM electrolyzers is 0.51 litres potable water per kWh H₂ HHV (https://assets.publishing.service.gov.uk/government/uploads/system/uploads/attachment_data/file/760479/H2_supply_chain_evidence_-_publication_version.pdf)

⁹⁷ LBST, 2016, Power-to-Liquids Potentials and Perspectives for the Future Supply of Renewable Aviation Fuel http://www.lbst.de/news/2016_docs/161005_uba_hintergrund_ptl_barrierefrei.pdf

Methanol routes

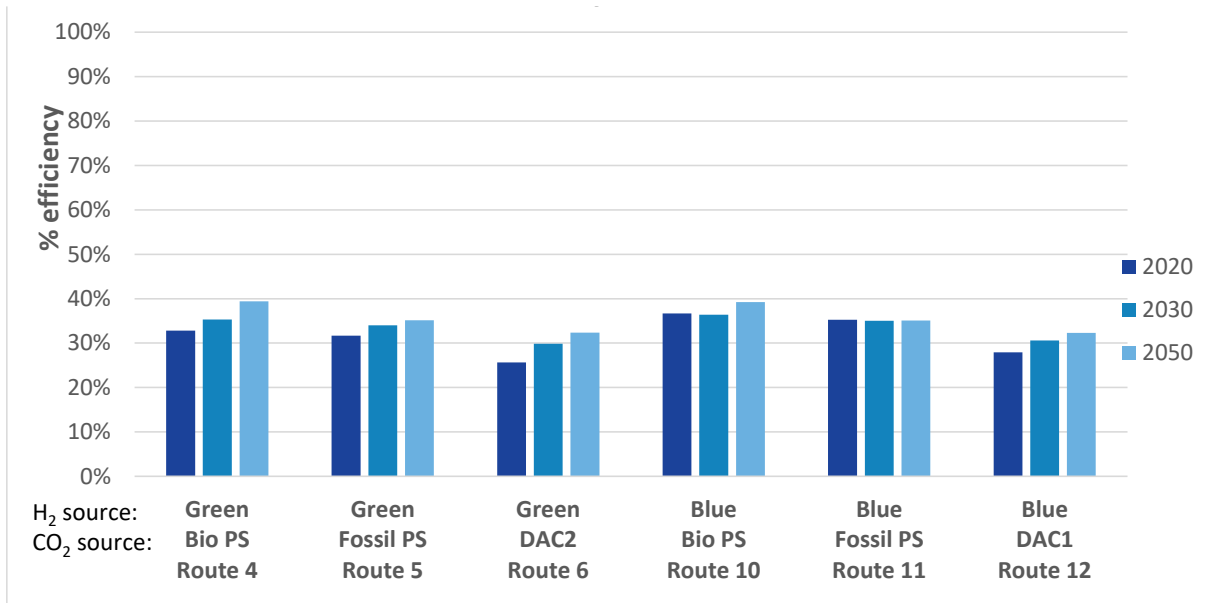

Figure 53: LHV energy efficiency for methanol routes

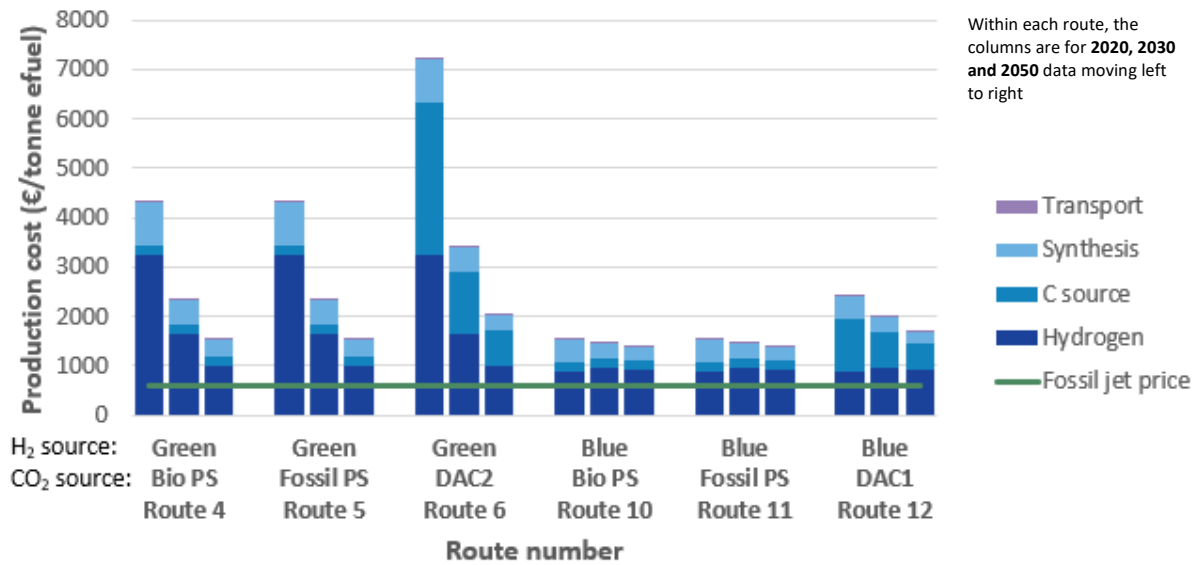

Figure 54: Production costs for methanol routes

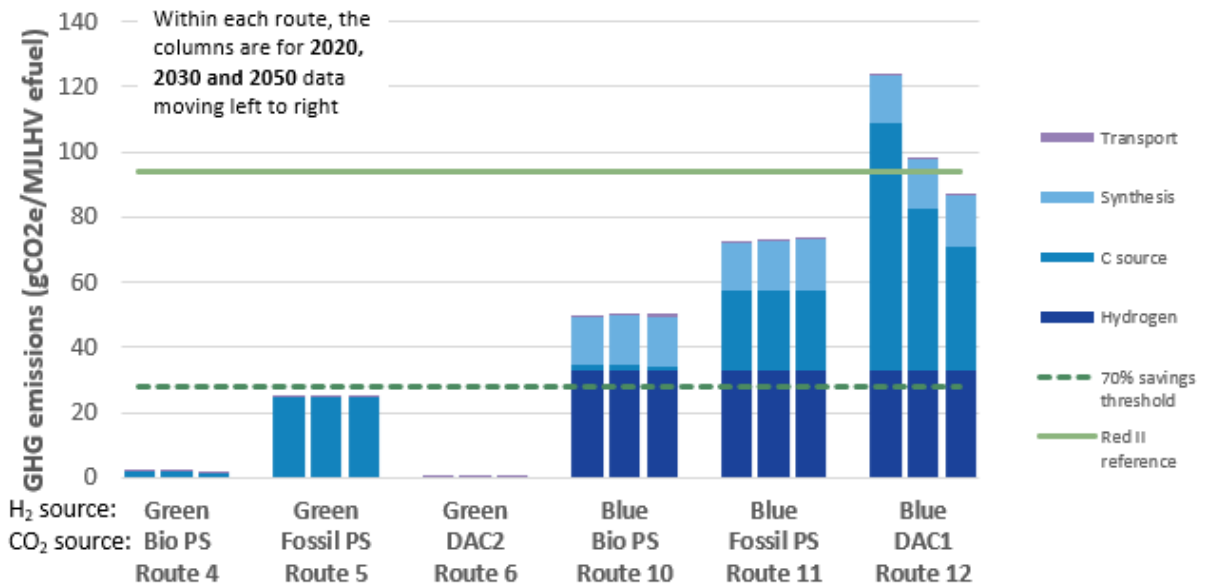

Figure 55: GHG emissions for methanol routes

The input parameters used in the model are subject to considerable uncertainty and consequently a sensitivity analysis has been carried out to highlight the effect on fuel prices of varying certain input parameters.

Sensitivity analysis

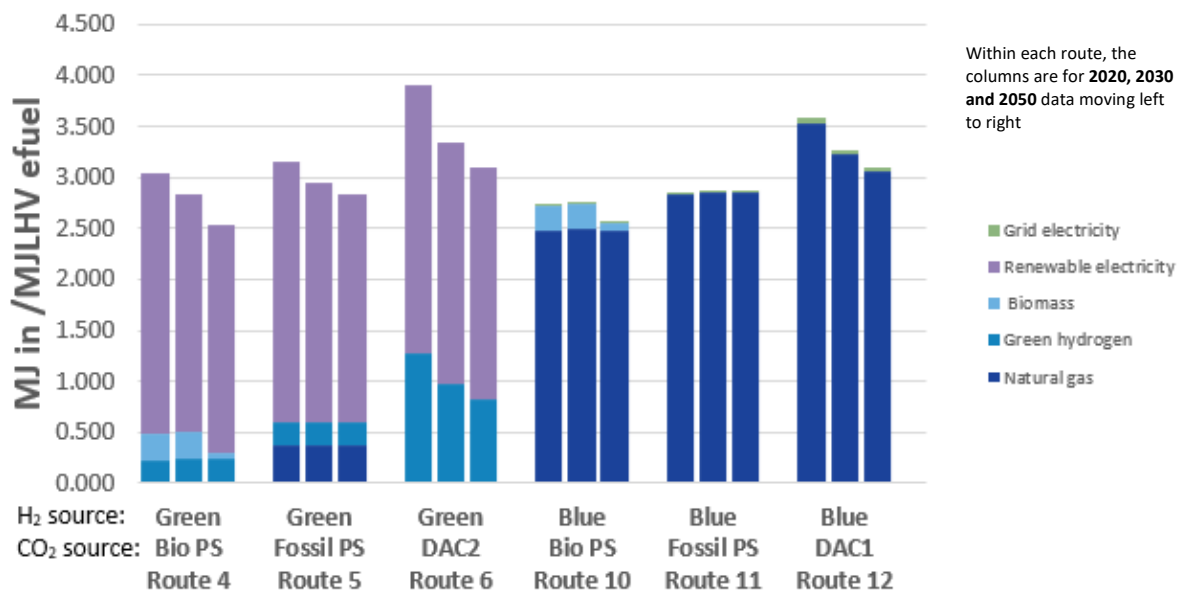

Figure 56: Source of energy input

Figure 56 shows the energy requirement for each route differentiated by energy source. It can therefore be implied how changes in either the costs or the GHG emissions of these constituent components will impact the overall chain as a whole. More detailed sensitivity analyses on specific parameters were carried out and displayed below for the FT routes.

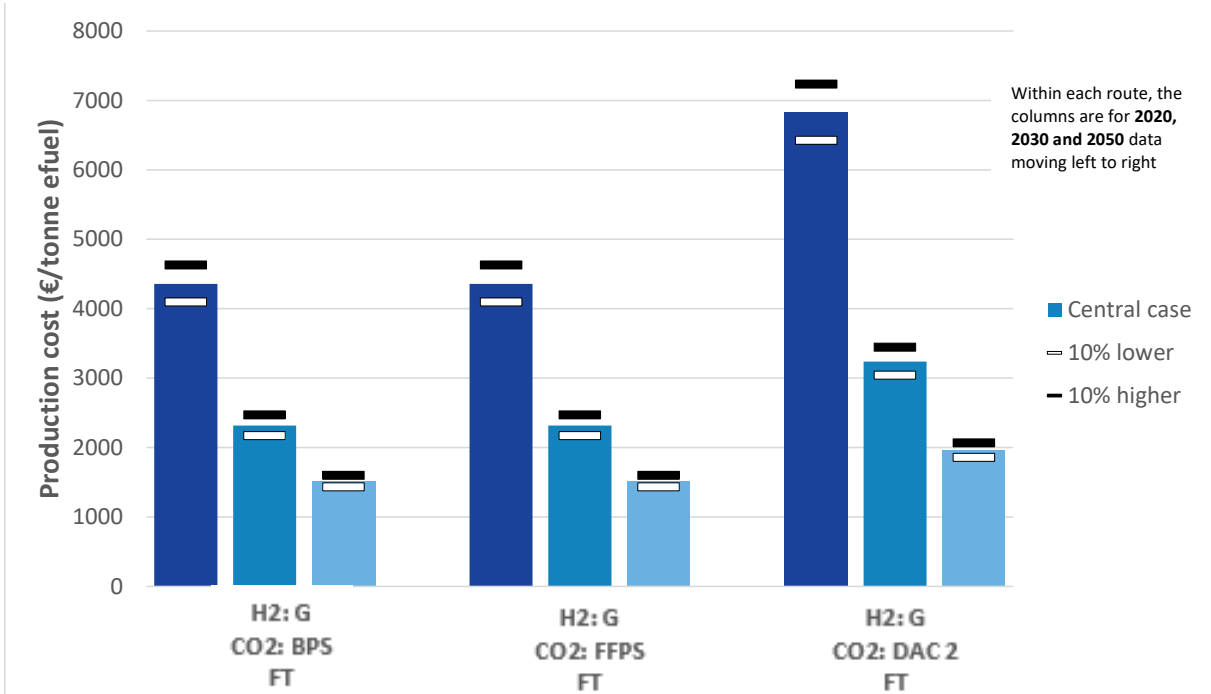

Figure 57: Sensitivity of synthetic kerosene cost to renewable electricity price (green H2 routes)

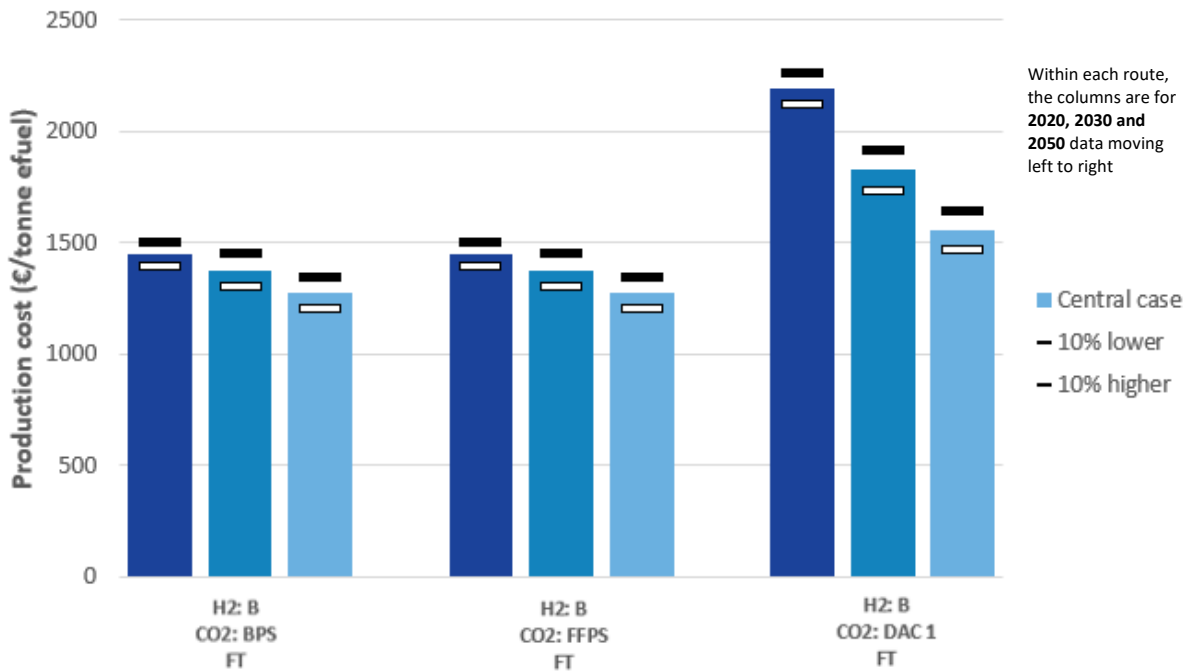

Figure 58: Sensitivity of synthetic kerosene cost to natural gas price (blue H2 routes)

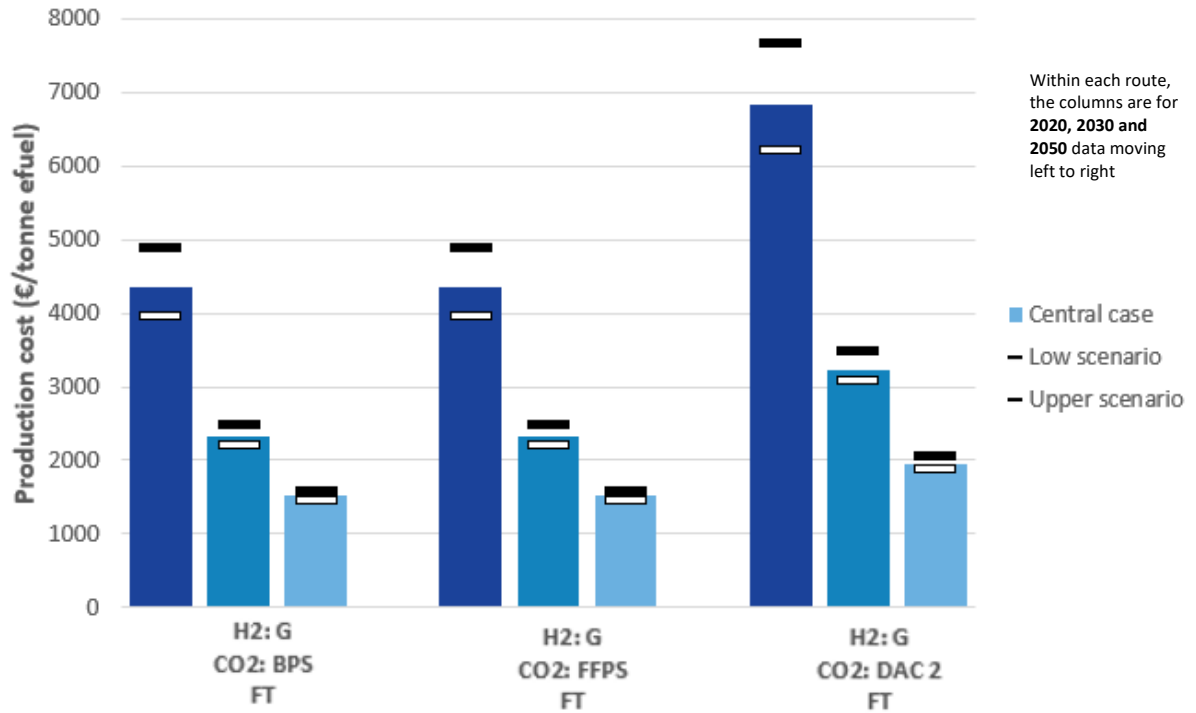

Figure 59: Sensitivity of synthetic kerosene cost to electrolyser efficiency (green H2 routes)

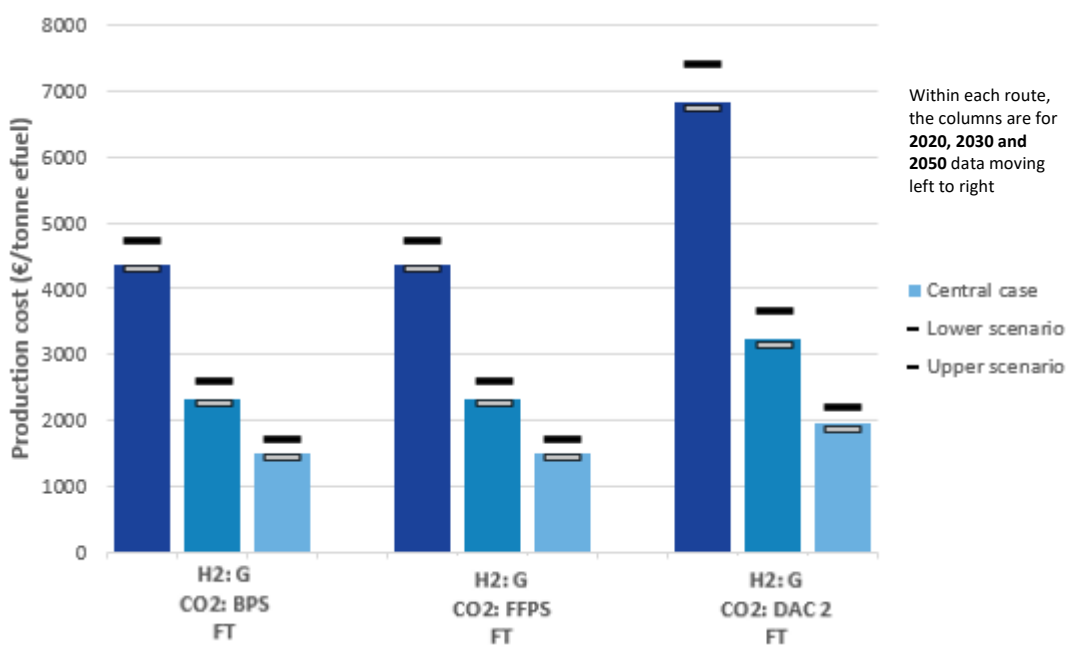

Figure 60: Sensitivity of synthetic kerosene cost to electrolyser CAPEX (green H2 routes)

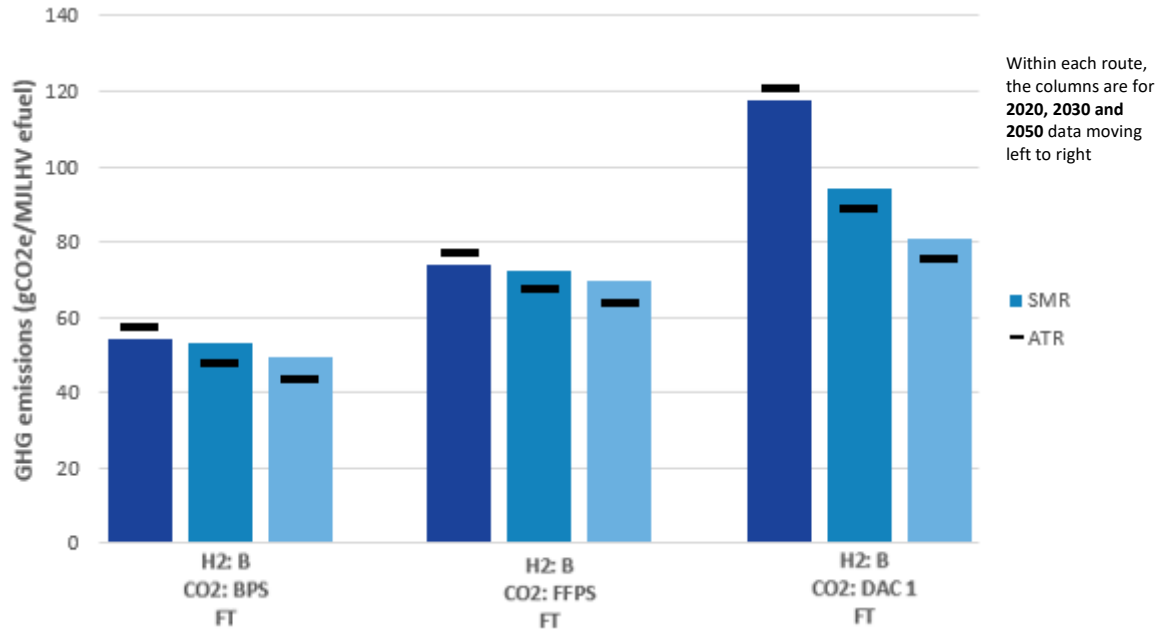

Figure 61: Sensitivity of synthetic kerosene cost to substituting SMR with ATR (blue H2 routes)

SMR has no electricity input whereas ATR does, so the lifecycle GHG emissions improve as the grid decarbonises.

Appendix C : Descriptions of Water Gas Shift (WGS) and Reverse Water Gas Shift (RWGS)

Water Gas Shift Reaction	Reverse Water Gas Shift Reaction
<p>In the WGSR, water reacts with CO to form hydrogen and carbon dioxide ($\text{CO} + \text{H}_2\text{O} \leftrightarrow \text{CO}_2 + \text{H}_2$), where the CO_2 can be separated from the stream to get pure hydrogen⁹⁸</p>	<p>The RWGS reaction is the reversible hydrogenation of CO_2 to produce CO and H_2O⁹⁹. The RWGS is equilibrium limited, and favoured at high temperatures (600-900°C) due to the endothermic nature of the reaction¹⁰⁰. The heat input requirement makes RWGS a more complex technical system compared to WGS.</p>
<p>The WGS reaction mechanism is considered to be complicated due to the sensitivity of the catalysts to minor changes in operational conditions. There are two prominent mechanisms for the WGS reaction: the regenerative (redox) mechanism and the associative (Langmuir-Hinshelwood) mechanism. Generally, at high temperatures, the WGS reaction is accepted to follow the redox mechanism, where CO molecule adsorbs on the catalyst surface and abstracts one oxygen from the metal-oxide support to form carbon dioxide. Loss of oxygen from metal-oxide creates an oxygen vacancy that is fulfilled by dissociating a water molecule to generate hydrogen and oxygen atoms. Hydrogen atoms combine and desorb as hydrogen gas whereas oxygen atom is captured by the oxygen deficient metal-oxide. The associative mechanism, on the other hand, has been reported at low as well as high temperatures, usually proceeds by the adsorption of CO and H_2O on the catalysts surface leading to a reactive intermediate that subsequently decomposes to produce CO_2 and H_2. Nonetheless, the redox mechanism is still the most widely accepted mechanism for WGSR¹⁰¹.</p>	<p>Numerous studies have been carried out regarding catalysis of the RWGS reaction. Iron based catalysts are often considered as one of the most successful active metals for higher temperatures, due to its thermal stability and high oxygen mobility. Typically iron works in the high temperature range and for lower temperatures copper is often regarded to be successful due to its enhanced adsorption of reaction intermediates at these lower temperatures¹⁰².</p>
<p>WGSR is a well-established procedure in conventional chemical/hydrocarbon industries for the production of ammonia, methanol, hydrogen, saturated hydrocarbons, and many other chemicals and petrochemicals¹⁰³.</p>	<p>Only a few plants have been installed until now (e.g. at the Sunfire PTL pilot plant in Dresden, at KIT in Karlsruhe, and at the SOLETAIR PTL pilot plant in Lappeenranta in Finland)</p>

⁹⁸ Available at: <https://link.springer.com/content/pdf/10.1007/s42247-020-00116-y.pdf>

⁹⁹ Available at: <https://www.sciencedirect.com/science/article/pii/S221298201730433X>

¹⁰⁰ Available at: <https://par.nsf.gov/servlets/purl/10104077>

¹⁰¹ Available at: <https://link.springer.com/content/pdf/10.1007/s42247-020-00116-y.pdf>

¹⁰² Available at: <https://www.sciencedirect.com/science/article/pii/S221298201730433X>

¹⁰³ Available at: <https://link.springer.com/content/pdf/10.1007/s42247-020-00116-y.pdf>